

Visit CrimpSource at [www.parker.com/crimpsource](http://www.parker.com/crimpsource), your online resource for hose crimp specifications.

# Equipment C



ENGINEERING YOUR SUCCESS.

A

B

C

D

E

<p>Karrykrimp C-8</p> 	<p>Karrykrimp Bench Mount C-8</p> 	<p>Karrykrimp 2 C-10</p> 
<p>Karrykrimp 2 Bench Mount C-10</p> 	<p>Parkrimp 2 C-12</p> 	<p>Minikrimp C-14</p> 
<p>Portable Pumps C-16</p> 	<p>Crimpsource C-17</p> 	<p>Parkrimp and Twin-Tough Instructions C-18-21</p> 
<p>Conversion Kits C-22</p> 	<p>332T-115V C-23</p>  <p>Hose Cut-Off Machine</p>	<p>239 and 339 C-23</p>  <p>Hose Cut-Off Machine</p>



<p>631075 C-23</p>  <p><i>Karrykut - Hose Cut-Off Machine</i></p>	<p>Hose Cut-Off Machine C-23</p>  <p><i>TH3-51</i></p>	<p>TH6-10-HL-9-2 C-24</p>  <p><i>Ultra Clean Hose Cleaning Kit</i></p>
<p>TH6-10-EL-7 C-24</p>  <p><i>Economy Hose Cleaning Kit</i></p>	<p>871522 C-26</p>  <p><i>Handycut - Hose Cut-Off Machine</i></p>	<p>881540 C-26</p>  <p><i>Push-Lok Cut-Off &amp; Assembly Tool</i></p>
<p>TH9-1 C-26</p>  <p><i>Hose Insertion Depth Blocks</i></p>	<p>TH11-1 C-26</p>  <p><i>Hose Cut-Off Tool</i></p>	<p>432-115V C-27</p>  <p><i>Hozemblem</i></p>
<p>80C-0DR and 83C-0DR C-27</p>  <p><i>Die Storage Racks</i></p>	<p>80C-SDR C-27</p>  <p><i>Swivel Die Rack</i></p>	<p>TH2-7 C-27</p>  <p><i>Fittings Push-On Stand</i></p>
<p>652200 C-28</p>  <p><i>Mandrel Tool Kit - 22 Series</i></p>	<p>2727 and 2726 C-28</p>  <p><i>Mandrel Tool Kit - 23 Series</i></p>	<p>TH2-7M25-6, TH2-7M25-8 C-28</p>  <p><i>Mandrels - 25 Series</i></p>
<p>652201 C-28</p>  <p><i>Assembly Tools - 22 Series</i></p>	<p>601069 C-29</p>  <p><i>Hose Perforator</i></p>	<p>Hose Oil C-29</p>  <p><i>Hose Oil</i></p>

A

B

C

D

E

A

<p>Lubricant C-29</p>  <p><i>Accrolube - High Efficiency</i></p>	<p>Small Crimper Hood C-29</p> 	<p>Large Crimper Hood C-29</p> 
---	--	--

B

C

D

E

A

B

C

D

E

# Hose Assemblies Are Easy With the Parkrimp System.

Since its introduction in 1980, the Parkrimp family of crimping machines has led the industry in ease of use and rugged durability.

When it comes to hose assemblies, no one puts it all together like Parker. From high-volume productivity to portable on-site assembly, we offer a variety of crimping machines, No-Skive hoses, and No-Skive fittings to meet your needs.

With Parkrimp equipment, anyone can make factory-quality hose assemblies quickly, easily, and cost effectively. Parkrimp machines are simple to operate and they're built to provide years of dependable service. Seven Parkrimp models – an entire family of crimpers – are available to meet your bench-mounted or portable needs, crimping straight or bent-stem fittings from 1/4" to 2" in diameter. Just use our No-Skive hoses and fittings to create leak-free hose assemblies whenever and wherever you need them.

The complete system from one source: No-Skive hose, No-Skive fittings, and crimping machines with worldwide availability and service.



With Parkrimp, you benefit from a full length crimp.

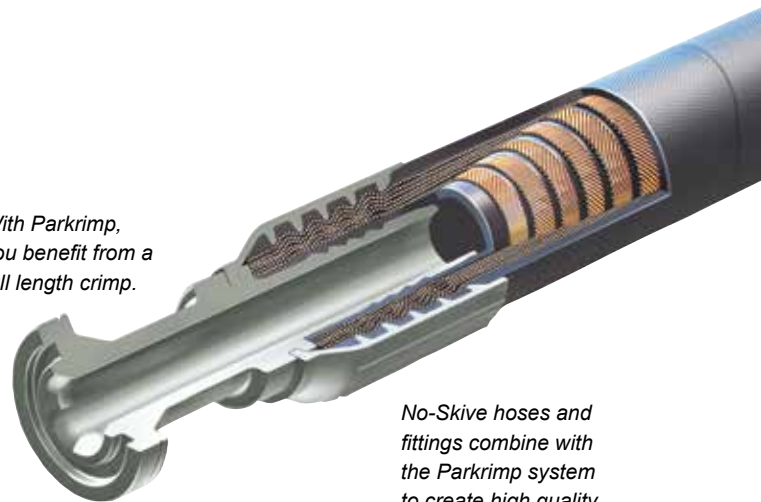

Our low profile design makes routing hose assemblies easy.

No-Skive hoses and fittings combine with the Parkrimp system to create high quality, reliable hydraulic hose assemblies every time.

Eight segment crimp dies provide a smooth, even, 360-degree crimp.

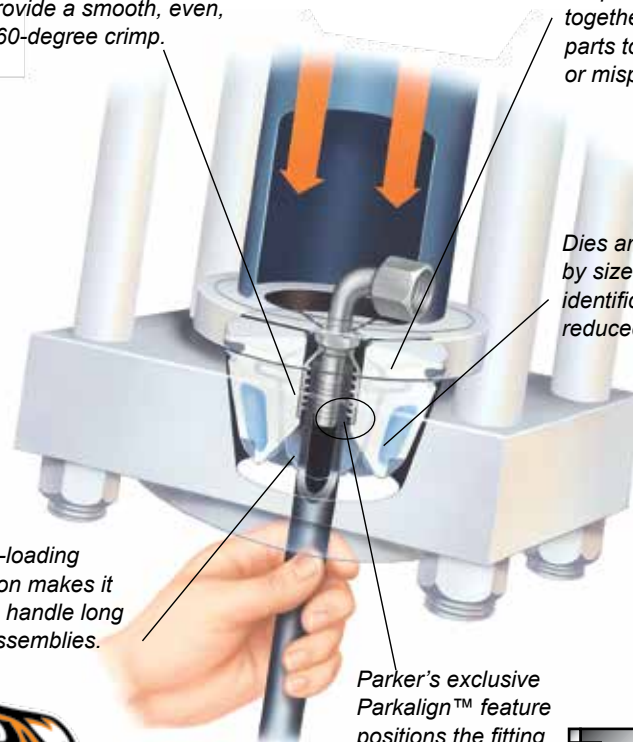

Our linked crimp dies keep die segments together. No loose parts to mismatch or misplace.

Dies are color-coded by size for easy identification and reduced set-up time.

Bottom-loading operation makes it easy to handle long hose assemblies.

Parker's exclusive Parkalign™ feature positions the fitting in the dies perfectly every time.

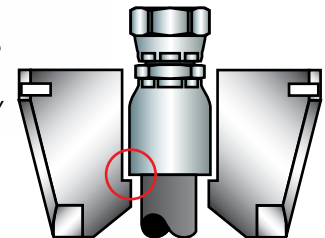

Be sure to check [www.parker.com/crimpsource](http://www.parker.com/crimpsource) for the most up to date information and crimp specifications.

## Selecting the right die.

Once the proper Parker Hose and Fitting is selected that meets your application requirements, you will need to select the proper die to assemble them together.

Based on the hose size and approved fitting, select the proper color coded die, as called out in the chart below.

**Example:**

Hose	451TC-4
Fitting	43 Series
Die Body Color	Silver
Die Cavity Color (-4)	<b>RED</b>

Based on the Parkrimp machine being used to assemble the hose and fitting, individual die part numbers and tooling selection for your assembly can be found in Section C of this catalog.

For general hose assembly instructions for all Parkrimp machines, please turn to pages C-18 and C-19. (An instructional video is a standard part of each Parkrimp machine shipped from the manufacturer.)

Parker Hose Products Division also offers a full line of crimping accessories, including conversion kits, cabinets, cut-off saws, push-on tables, die racks, and mandrel tool kits.



Hose Dash Size	Die Cavity Color Code	43 Series Die Body Color	70, 71 & 77 Series Die Body Color	73, 78, S6 & 79 Series Die Body Color	76 Series Die Body Color	25 Series Die Body Color	26 Series Die Body Color	81 Series Die Body Color
		Silver	Black	Olive Drab	Silver	Silver	Silver	Silver
-4	RED		N/A	N/A	N/A	N/A		N/A
-5	PURPLE		N/A	N/A	N/A	N/A		N/A
-6	YELLOW			N/A	N/A			N/A
-8	BLUE			N/A	N/A			N/A
-10	ORANGE			N/A	N/A	N/A		N/A
-12	GREEN					N/A		
-16	BLACK					N/A		
-20	WHITE				N/A	N/A		
-24	RED				N/A	N/A		
-32	GREEN				N/A	N/A		

Hose Dash Size	Die Cavity Color Code	HY Series Die Body Color
		Silver
-4	BROWN	
-5	BROWN	
-6	BROWN	
-8	BROWN	
-10	BROWN	
-12	BROWN	
-16	BROWN	



Reference pages C-8 through C-17 for specific tool information regarding hose, fitting, and crimper combinations.

A  
B  
C  
D  
E

# Karrykrimp



The Karrykrimp is now available in a modular design with all the familiar Parkrimp System advantages.

The same unit now offers portability and bench mountability.

## Capability

- Up to 1-1/4" ID 2 wire braided hose
- Up to 5/8" ID 4 wire spiral hose
- Only steel fittings

## Features

- Portable, compact rugged design
- Numerous portable power unit options available
- Pivoting pusher design for easy die change out
- Increased height enables longer bent tube fittings to be crimped
- For use with 25, 26, 43, 81, and HY Series fittings

## Specifications

- Dimensions: 15" wide, 12" deep, 30" high
- Weight: 60 lbs (without power unit)
- Rating: 30 ton force @ 10,000 psi maximum
- Full Cycle Time: 30 seconds 82C-0EP power unit (1/2" 43 Series)
- Reference page C-16 for information on available power units

## Standard Equipment

Part Number			Description	Individual Part Number
82C-CHD	82C-061L	82C-KKB		
●	●	●	Crimp Head	82C-CHD
		●	Bench Power Unit Assembly	85C-ZPH
●	●	●	Silver die ring	82C-R01
●	●	●	Black die ring	82C-R02
			Hose Assembly	85C-00L
	●		Stand Assembly	85C-STD

# Karrykrimp Bench Mount



## Capability

- Up to 1-1/4" ID 2 wire braided hose
- Up to 5/8" ID 4 wire spiral hose
- Only steel fittings

## Features

- Faster cycle times on bench mounted units
- Pivoting pusher design for easy die change out
- Compact bench mount design
- Increased height enables longer bent tube fittings to be crimped
- For use with 25, 26, 43, 81, and HY Series fittings

## Specifications

- Dimensions: 17" wide, 23" deep, 27-1/2" high
- Weight: 146 lbs
- Rating: 30 ton force @ 10,000 psi maximum
- Full Cycle Time: 11 seconds (1/2" 43 Series)
- Hydraulic Fluid: AW32 oil
- This unit is designed to make about 400 crimps per day and is not designed to be a production crimper. Exceeding these suggested production amounts will significantly reduce the the expectancy of the crimper components.

- **Note:** Motor is dual voltage, 50/60hz suitable for 208-230/115v, 1ph, 60hz and 220-230/110v, 1ph, 50hz. Motor can be rewired by a qualified electrician to operate at alternate voltage.



**Note:**







- For crimp instructions, see pages C-18 and C-19.
- Hose assemblies must be inspected for cleanliness and free of all foreign particles.
- Parker Hannifin will not accept responsibility for the operation of, or provide warranty coverage for, a crimper that is operated by a power unit other than equipment supplied by Parker Hannifin for the express purpose of operating the crimper.





Parker Hannifin Corporation  
Hose Products Division  
30240 Lakeland Blvd.  
Wickliffe, Ohio 44092

### Karrykrimp/Karrykrimp Bench Mount Hose Die Selection Chart

Fitting Series	HOSE	-4 RED	-5 PUR	-6 YEL	-8 BLU	-10 ORG	-12 GRN	-16 BLK	-20 WHT	Die Ring
43 Series	Die Part Number	80C-A04	80C-A05	80C-A06	80C-A08	80C-A10	80C-A12	80C-A16	80C-A20	
	351TC/ST 431 422 436 424 451TC/ST 472TC / LT 426 471TC/ST 482TC/ST	0.645 0.665	0.710 0.730	0.825 0.845	0.945 0.965	1.060 1.080	1.245 1.265	1.590 1.610	1.970 1.990	 SILVER
	421WC 304 601 302/301 341 604 301LT 381 881 722TC / LT (-6, -8, -10 ONLY)	0.685 0.705	0.750 0.770	0.865 0.885	0.985 1.005	1.100 1.120	1.285 1.305	1.630 1.650	2.010 2.030	 BLACK
26 Series	Die Part Number	80C-E04	80C-E05	80C-E06	80C-E08	80C-E10	80C-E12	80C-E16		
	213 285 293	0.460 0.480	0.520 0.540	0.575 0.595	0.670 0.690	0.805 0.825	0.915 0.935	1.175 1.195		 SILVER
	201 225 206 244 221FR 266 SS25UL	0.500 0.520	0.560 0.580	0.615 0.635	0.710 0.730	0.845 0.865	0.955 0.975	1.215 1.235		 BLACK
81 Series	Die Part Number						80C-V12	80C-V16	80C-V20	
	811 811HT 881						1.155 1.175	1.450 1.470	1.740 1.760	 SILVER
HY Series	Die Part Number	80C-H585		80C-H735	80C-H840	80C-H970	80C-H1120			
	AX	0.575 0.595		0.725 0.745	0.830 0.850	0.960 0.980	1.110 1.130			
	Die Part Number	80C-H605		80C-H775	80C-H885	80C-H1010	80C-H1170			
	BXX	0.635 0.655		0.805 0.825	0.915 0.935	1.040 1.060	1.200 1.220			
	Die Part Number	80C-H595		80C-H735	80C-H860	80C-H1015	80C-H1170	80C-H1365		
611HT 801 836	0.575 0.595		0.720 0.740	0.860 0.880	0.995 1.015	1.140 1.160	1.350 1.370		 SILVER	
Caution: Read the operations and technical manual before attempting to operate this machine. Do not operate this machine without guard in place. Keep hands clear of moving parts when operating machine.						Note: Do not use this machine to assemble 341-20, 451TC-20, 451ST-20, 472TC-20 or any size stainless steel fittings.				
For a new Decal, contact Parker at: 1-800-C-PARKER or print your own at <a href="http://www.parker.com/crimpsource">www.parker.com/crimpsource</a> . Decal Part Number: 82C-CRIMPDECAL										REV. A

A

B

C

D

E



## Karrykrimp 2

The Karrykrimp 2 is now available in a modular design with all the familiar Parkrimp System advantages.

The same unit now offers portability and bench mountability.



### Capability

- Up to 1-1/4" ID 2 wire braided hose
- Up to 1-1/4" ID 4 wire spiral hose
- Up to 1" ID 6 wire spiral hose

### Features

- Portable, compact rugged design
- Numerous portable power unit options available
- Pivoting pusher design for easy die change out
- For use with 25, 26, 43, 70, 71, 73, 77, 78, 81, and HY Series fittings

### Specifications

- Dimensions: 14" wide, 14" deep, 31-1/2" high
- Weight: 120 lbs (without power unit)
- Rating: 60 ton force @ 10,000 psi maximum
- Full Cycle Time: 20 seconds with 85C-0EP power unit (1/2" 43 series)
- Reference page C-16 for information on available power units

### Standard Equipment

Part Number			Description	Individual Part Number
85C-CHD	85C-061L	85C-KKB		
●	●	●	Crimp Head	85C-CHD
		●	Bench Power Unit Assembly	85C-1PH
●	●	●	Silver die ring	85C-R01
●	●	●	Black die ring	85C-R02
	●		Hose Assembly	85C-00L
	●		Stand Assembly	85C-STD

### Optional Tooling

- Die Kit (85C-KDA) Includes 43 Series dies in sizes 1/4", 3/8", 1/2", 3/4", 1" and 1-1/4" and 70/71 Series dies in sizes 3/8", 1/2", 3/4", 1", 1-1/4" **ONLY**.

**Note:**

- For crimp instructions, see pages C-18 and C-19.
- Hose assemblies must be inspected for cleanliness and free of all foreign particles.
- Parker Hannifin will not accept responsibility for the operation of, or provide warranty coverage for, a crimper that is operated by a power unit other than equipment supplied by Parker Hannifin for the express purpose of operating the crimper.

## Karrykrimp 2 Bench Mount



### Capability

- Up to 1-1/4" ID 2 wire braided hose
- Up to 1-1/4" ID 4 wire spiral hose
- Up to 1" ID 6 wire spiral hose

### Features

- Faster cycle times on bench mounted units
- Pivoting pusher design for easy die change out
- Compact bench mount design
- For use with 25, 26, 43, 70, 71, 73, 77, 78, 81, and HY Series fittings

### Specifications

- Dimensions: 17" wide, 23" deep, 28" high
- Weight: 208 lbs
- Rating: 60 ton force @ 10,000 psi maximum
- Full Cycle Time: 17 seconds (1/2" 43 series)
- Hydraulic Fluid: AW32 oil
- This unit is designed to make about 400 crimps per day and is not designed to be a production crimper. Exceeding these suggested production amounts will significantly reduce the expectancy of the crimper components.

- **Note:** Motor is dual voltage, 50/60hz suitable for 208-230/115v, 1ph, 60hz and 220-230/110v, 1ph, 50hz. Motor can be rewired by a qualified electrician to operate at alternate voltage.





Parker Hannifin Corporation  
Hose Products Division  
30240 Lakeland Blvd.  
Wickliffe, Ohio 44092

### Karrykrimp 2/Karrykrimp 2 Bench Mount Hose Die Selection Chart

Fitting Series	HOSE	-4 RED	-5 PUR	-6 YEL	-8 BLU	-10 ORG	-12 GRN	-16 BLK	-20 WHT	Die Ring		
43 Series	Die Part Number	80C-A04	80C-A05	80C-A06	80C-A08	80C-A10	80C-A12	80C-A16	80C-A20			
	351TC/ST 422 424 426	431 436 451TC/ST 471TC/ST	472TC/LT 482TC/ST	0.645 0.665	0.710 0.730	0.825 0.845	0.945 0.965	1.060 1.080	1.245 1.265	1.590 1.610	1.970 1.990	
	421WC 302 301LT	304 341 381 722ST / TC / LT	601 604 881	0.685 0.705	0.750 0.770	0.865 0.885	0.985 1.005	1.100 1.120	1.285 1.305	1.630 1.650	2.010 2.030	
70 Series	Die Part Number				83C-D06	83C-D08	83C-D10					
	701 F42 (-8 Only)				0.990 1.010	1.140 1.160	1.260 1.280				BLACK	
71 Series	Die Part Number				83C-D06	83C-D08	83C-D10	83C-D12	83C-D16	83C-D20		
	711 721 721TC	721ST 722TC 772LT	772ST 774	DO NOT USE THIS MACHINE TO ASSEMBLE ANY 71 SERIES SIZE-20 STAINLESS FITTINGS			0.950 0.970	1.100 1.120	1.220 1.240	1.355 1.375	1.695 1.715	2.025 2.045
73 Series	Die Part Number							80C-L12	80C-L16			
	731							1.420 1.440	1.730 1.750			
77 Series	Die Part Number					80C-CS08	80C-CS10	80C-CS12				
	787TC 797TC					0.930 0.950	1.057 1.077	1.245 1.265				
78 Series	Die Part Number							80C-L12	80C-L16			
	781 782TC 782ST							1.420 1.440	1.730 1.750			
25 Series	Die Part Number				80C-Y06	80C-Y08						
	271				0.680 0.700	0.825 0.845					SILVER	
26 Series	Die Part Number	80C-E04	80C-E05	80C-E06	80C-E08	80C-E10	80C-E12	80C-E16				
	213 285 293	0.460 0.480	0.520 0.540	0.575 0.595	0.670 0.690	0.805 0.825	0.915 0.935	1.175 1.195				
	201 206 221FR	225 244 266	SS25UL	0.500 0.520	0.560 0.580	0.615 0.635	0.710 0.730	0.845 0.865	0.955 0.975	1.215 1.235		
81 Series	Die Part Number							80C-V12	80C-V16	80C-V20		
	811 811HT 881							1.155 1.175	1.450 1.470	1.740 1.760	SILVER	
HY Series	Die Part Number	80C-H585			80C-H735	80C-H840	80C-H970	80C-H1120	80C-H1365			
	AX	0.575 0.595			0.725 0.745	0.830 0.850	0.960 0.980	1.110 1.130	1.355 1.375			
	Die Part Number	80C-H605			80C-H775	80C-H885	80C-H1010	80C-H1170	80C-H1465	80C-H1880		
	BXX	0.635 0.655			0.805 0.825	0.915 0.935	1.040 1.060	1.200 1.220	1.495 1.515	1.910 1.930	BLACK	
	Die Part Number	80C-H595			80C-H735	80C-H860	80C-H1015	80C-H1170	80C-H1365			
611HT 801 836	0.575 0.595			0.720 0.740	0.860 0.880	0.995 1.015	1.140 1.160	1.350 1.370				

Caution: Read the operations and technical manual before attempting to operate this machine. Do not operate this machine without guard in place. Keep hands clear of moving parts when operating machine.

Note: Stainless steel crimp diameters are 0.010" greater than table listings with the exception of HY series which are 0.005" greater than table listings.

For a new Decal, contact Parker at: 1-800-C-PARKER or print your own at [www.parker.com/crimpsource](http://www.parker.com/crimpsource).  
Decal Part Number: 85C-CRIMPDECAL

REV. B

A

B

C

D

E



# Parkrimp 2



A

B

C

D

E

## Capability

- Up to 2" ID 2 wire braided hose
- Up to 2" ID 4/6 wire spiral hose

## Features

- Easy to use vertical design
- Crimps full range of Parker hoses from 1/4" through 2" I.D.
- Crimps both steel and stainless steel fittings
- For use with 25, 26, 43, 70, 71, 73, 76, 77, 78, 79, 81, S6 and HY Series fittings

## Specifications

- Dimensions: 31" wide, 24" deep, 77" high
- Weight: 842 lbs (Head is 558 lbs and base is 284 lbs)
- Rating: 125 ton force @ 5,000 psi maximum
- Full Cycle Time: 30 seconds without adapter bowl  
20 seconds with adapter bowl
- Hydraulic oil: Enerpac oil

## Standard Equipment

Part Number				Description	Individual Part Number
83C-001	83C-081	83C-002	83C-082		
●	●	●	●	Parkrimp 2 crimper head assembly	83C-080
●	●			Parkrimp 2 stand assembly with 230/460 volt, 3 phase, 50/60 Hz power unit (wired for 230 volt)	83C-S40
		●	●	Parkrimp 2 stand assembly with 230 volt, 1 phase, 50/60 Hz power unit	83C-S20
●	●	●	●	Adapter bowl	83C-OCB
●	●	●	●	Spacer ring	83C-R02
●	●	●	●	Spacer Plate	83C-R02H
●		●		Die Kit Includes 43 Series dies in sizes 1/4", 3/8", 1/2", 3/4", 1", 1-1/4" dies and 70/71 Series dies in sizes 3/8", 1/2", 3/4", 1", 1-1/4", 1-1/2", 2" ONLY	83C-KDA

**Note:**

- For crimp instructions, see pages C-18 and C-19.
- Hose assemblies must be inspected for cleanliness and free of all foreign particles.
- Parker Hannifin will not accept responsibility for the operation of, or provide warranty coverage for, a crimper that is operated by a power unit other than equipment supplied by Parker Hannifin for the express purpose of operating the crimper.



Parker		Parker Hannifin Corporation Hose Products Division 30240 Lakeland Blvd. Wickliffe, Ohio 44092		Parkrimp 2 Hose Die Selection Chart										
Fitting Series	HOSE			-4 RED	-5 PUR	-6 YEL	-8 BLU	-10 ORG	-12 GRN	-16 BLK	-20 WHT	-24 RED	-32 GRN	
	Die Part Number			80C-A04	80C-A05	80C-A06	80C-A08	80C-A10	80C-A12	80C-A16	80C-A20	80C-A24	80C-A32	
43 Series	351TC	431	471ST	0.645	0.710	0.825	0.945	1.060	1.245	1.590	1.970	2.290	2.735	
	351ST	436	472TC											
	422	451TO	472LT											
	424	451ST	486TC											
	426	471TC	482ST							83C-A16H	83C-A20H			
	Tooling Required													
	421WC	304	601	0.685	0.750	0.865	0.985	1.100	1.285	1.630	2.010	2.330	2.775	
	302	341	604											
	301LT	381	881											
	722ST / TC / LT (-6 THRU -20 ONLY)			0.705	0.770	0.885	1.005	1.120	1.305	1.650	2.030	2.350	2.795	
	Tooling Required													
70 Series	Die Part Number			83C-D06		83C-D08	83C-D10							
	701			0.990		1.140	1.260							
	F42 (-8 Only)			1.010		1.160	1.280							
	Tooling Required													
71 Series	Die Part Number			83C-D06		83C-D08	83C-D10	83C-D12	83C-D16	83C-D20	83C-D24	83C-D32		
	711	721ST	772TC	0.950	1.100	1.220	1.355	1.375	1.695	2.025	2.290	2.775		
	721	721TC	772ST											
721TC	774	774												
	722ST / TC / LT (-24 and -32 Only)			0.970	1.120	1.240	1.375	1.715	2.045	2.310	2.795			
	Tooling Required													
73 Series	Die Part Number			83C-L12		83C-L16	83C-L20	83C-L24	83C-L32					
	731			1.420		1.730	2.140	2.440	3.025					
	Tooling Required			1.440		1.750	2.160	2.460	3.045					
	Tooling Required													
76 Series	Die Part Number			83C-U12		83C-U16								
	761			1.540		1.865								
	Tooling Required			1.560		1.885								
	Tooling Required													
77 Series	Die Part Number			80C-CS08		80C-CS10	80C-CS12	83C-CS16	83C-CS20	83C-CS24	83C-CS32			
	787TC			0.930		1.057	1.245	1.541	1.970	2.320	2.865			
	797TC			0.950		1.077	1.265	1.561	1.990	2.340	2.885			
	Tooling Required										SIZE -32 IS FOR STEEL FITTINGS ONLY			
78/86 Series	Die Part Number			83C-L12		83C-L16	83C-L20	83C-L24	83C-L32					
	P35	781	782ST	1.420		1.730	2.140	2.440	3.025					
	782TC			1.440		1.750	2.160	2.460	3.045					
	Tooling Required			S6 Series Fittings are used on P35-32 Hose Only										
	Tooling Required													
79 Series	Die Part Number			83C-L12		83C-L16	83C-L20	83C-L24						
	791TC	792TC	792ST	1.420		1.730	2.140	2.440	2.160					
	792LT	F42	1.440		1.750	2.160	2.460	2.460						
	Tooling Required													
25 Series	Die Part Number			80C-Y06		80C-Y08								
	271			0.680		0.825								
	Tooling Required			0.700		0.845								
	Tooling Required													
26 Series	Die Part Number			80C-E04	80C-E05	80C-E06	80C-E08	80C-E10	80C-E12	80C-E16	83C-E20	83C-E24	83C-E32	
	213	285	293	0.460	0.520	0.575	0.670	0.805	0.915	1.175	1.420	1.670	2.160	
				0.480	0.540	0.595	0.690	0.825	0.935	1.195	1.440	1.690	2.180	
	Tooling Required													
	201	225	SS25UL	0.500	0.560	0.615	0.710	0.845	0.955	1.215	1.460	1.710	2.200	
	206	244	SS23CG											
	221FR	266												
	Tooling Required			0.520		0.580	0.635	0.730	0.865	0.975	1.235	1.480	1.730	2.220
	Tooling Required													
81 Series	Die Part Number			80C-V12		80C-V16	80C-V20	83C-V24	83C-V32					
	811	811HT	881	1.155		1.450	1.740	2.010	2.430					
	Tooling Required			1.175		1.470	1.760	2.030	2.450					
	Tooling Required													
HY Series	Die Part Number			80C-H585		80C-H735	80C-H840	80C-H970	80C-H1120	80C-H1365				
	AX			0.575		0.725	0.830	0.960	1.110	1.355				
	Tooling Required			0.595		0.745	0.850	0.980	1.130	1.375				
	Tooling Required													
	Die Part Number			80C-H605		80C-H775	80C-H885	80C-H1010	80C-H1170	80C-H1465	80C-H1890			
	BXX			0.635		0.805	0.915	1.040	1.200	1.495	1.910			
	Tooling Required			0.655		0.825	0.935	1.060	1.220	1.515	1.930			
	Tooling Required													
	Die Part Number			80C-H595		80C-H735	80C-H860	80C-H1015	80C-H1170	80C-H1365				
	611HT			0.575		0.720	0.860	0.995	1.140	1.350				
	801			0.595		0.740	0.880	1.015	1.160	1.370				
	836			0.575		0.720	0.860	0.995	1.140	1.350				
	Tooling Required			0.595		0.740	0.880	1.015	1.160	1.370				
	Tooling Required													

Caution: Read the operations and technical manual before attempting to operate this machine. Do not operate this machine without guard in place. Keep hands clear of moving parts when operating machine.

Note: Stainless steel crimp diameters are 0.010" greater than table listings with the exception of HY series which are 0.005" greater than table listings. Do not use lubricant to assemble spiral hose and fittings.

83C-R12 Split Die ring is used for all crimping operations

80C-xxx/83C-xxx small dies and 83C-OCB adapter bowl used on sizes -4 thru -20

83C-R02 Spacer Ring used with adapter bowl when called out above

83C-xxx Large dies used on sizes -16 thru -32

83C-R02H Spacer Plate used when called out above

For a new Decal, contact Parker at: 1-800-C-PARKER or print your own at [www.parker.com/crimpsource](http://www.parker.com/crimpsource).  
Decal Part Number: 83C-CRIMPDECAL

REV C

A

B

C

D

E

# Minikrimp™

A



94C-002-PFD



94C-001-PFD

B

## Capability

- Up to 1" ID 2 wire braided hose
- Only steel fittings

C

## Features

- Light weight, portable, compact all-in-one unit
- Handpump or air over hydraulic design
- Removable pusher design for easy die change out
- Reference page C-16 for information on available power units
- For use with 25, 26, 43, 81, and HY Series fittings
- Do not crimp stainless steel fittings

D

## Specifications

- Dimensions: 6" wide, 13" deep, 15" high
- Weight: 42 lbs (with hand pump)
- Rating: 30 ton force @ 10,000 psi maximum
- Full Cycle Time: 30 seconds

E

## Important

The Minikrimp was developed by Parker Hannifin Parflex Division but is compatible with Parker Hannifin Hose Products Division products. Refer to Crimpsource™ on [www.parker.com/crimpsource](http://www.parker.com/crimpsource) (the online resource for hose crimp specifications for the complete line of Parker crimping machines). Any engineering and crimper performance issues pertaining to the Minikrimp should be directed to the Parflex Division, Technical Services Department, at (330) 296-2871 or fax, at (330) 296-8433.

## Standard Equipment

Part Number		Description	Individual Part Number
94C- 001-PFD	94C- 002 -PFD		
●	●	Base unit	94C-080-PFD
●		Hand pump	015301
	●	Air over hydraulic pump kit with tubing and adapters	025411
●	●	Silver die ring	82C-R01-PFD

## Optional Tooling

- Side Vise Mount (015736)
- Upright Table Mount (015306)
- Upright Vise Mount (015307)
- Black Die Ring (82C-R02-PFD)
- Connection Hose with Quick Coupling (015309)
- Bent Tube for Hand Pump Only (015308)
- Bent Tube for Air Over Hydraulic Pump Only (025349)

### Note:

- For crimp instructions, see pages C-18 and C-19.
- Hose assemblies must be inspected for cleanliness and free of all foreign particles.
- Parker Hannifin will not accept responsibility for the operation of, or provide warranty coverage for, a crimper that is operated by a power unit other than equipment supplied by Parker Hannifin for the express purpose of operating the crimper.





Parker Hannifin Corporation  
Hose Products Division  
30240 Lakeland Blvd.  
Wickliffe, Ohio 44092

### Minikrimp Hose Die Selection Chart

Fitting Series	HOSE	-4 RED	-5 PUR	-6 YEL	-8 BLU	-10 ORG	-12 GRN	-16 BLK	Die Ring
43 Series	Die Part Number	80C-A04	80C-A05	80C-A06	80C-A08	80C-A10	80C-A12	80C-A16	
	351TC/ST 431 472TC 422 436 472LT 424 451TC/ST 482TC/ST 426 471TC/ST	0.645	0.710	0.825	0.945	1.060	1.245	1.590	
		0.665	0.730	0.845	0.965	1.080	1.265	1.610	SILVER
	421WC 304 601 302/301 341 604 301LT 381 881 722ST / TC / LT (-6, -8, -10 ONLY)	0.685	0.750	0.865	0.985	1.100	1.285	1.630	
		0.705	0.770	0.885	1.005	1.120	1.305	1.650	BLACK
26 Series	Die Part Number	80C-E04	80C-E05	80C-E06	80C-E08	80C-E10	80C-E12	80C-E16	
	213 285 293	0.460	0.520	0.575	0.670	0.805	0.915	1.175	
		0.480	0.540	0.595	0.690	0.825	0.935	1.195	SILVER
81 Series	Die Part Number						80C-V12	80C-V16	
	811 811HT 881						1.155	1.450	
HY Series	Die Part Number	80C-H585		80C-H735	80C-H840	80C-H970	80C-H120		
	AX	0.575		0.725	0.830	0.960	1.110		
		0.595		0.745	0.850	0.980	1.130		SILVER
	Die Part Number	80C-H605		80C-H775	80C-H885	80C-H1010	80C-H1180		
	BXX	0.635		0.805	0.915	1.040	1.200		
		0.655		0.825	0.935	1.060	1.220		BLACK
	Die Part Number	80C-H595		80C-H735	80C-H860	80C-H1015	80C-H1170	80C-H1365	
	611HT 801 836	0.575		0.720	0.860	0.995	1.140	1.350	
		0.595		0.740	0.880	1.015	1.160	1.370	SILVER
Caution: Read the operations and technical manual before attempting to operate this machine. Do not operate this machine without guard in place. Keep hands clear of moving parts when operating machine.						Note: Do not use this machine to assemble stainless steel fittings with any hose listed on this chart.			
For a new Decal, contact Parker at: 1-800-C-PARKER or print your own at <a href="http://www.parker.com/crimpsource">www.parker.com/crimpsource</a> . Decal Part Number: 800C-CRIMPDECAL									REV. A

A

B

C

D

E



A

### Hand Pump

Part No. 82C-0HP



*(for use with the Minikrimp, Karrykrimp and Karrykrimp 2)*

Ease of operation hand pump delivers 10,000 psi

Length: 23"  
Width: 4"  
Height: 5"  
Port Size: 3/8" NPTF  
Weight: 9 lbs  
Hydraulic Fluid: Enerpac oil

### Hand Pump

Part No. 85C-0HP



*(for use with the Minikrimp, Karrykrimp and Karrykrimp 2)*

Ease of operation hand pump delivers 10,000 psi

Length: 29"  
Width: 13"  
Height: 11"  
Port Size: 3/8" NPTF  
Weight: 61 lbs  
Hydraulic Fluid: Enerpac oil

B

### Electric Pump

Part No. 82C-0EP



*(for use with the Minikrimp, Karrykrimp and Karrykrimp 2)*

Ease of operation electric pump delivers 10,000 psi

Length: 13"  
Width: 13"  
Height: 15"  
Port Size: 3/8" NPTF  
Weight: 31 lbs  
Hydraulic Fluid: Enerpac oil  
115 volt, 1 phase, 50/60 Hz, 9 amp

### Electric Pump

Part No. 85C-0EP



*(for use with the Minikrimp, Karrykrimp and Karrykrimp 2)*

Heavy duty electric pump delivers 10,000 psi at a faster cycle time

Length: 19"  
Width: 11"  
Height: 17"  
Port Size: 3/8" NPTF  
Weight: 59 lbs  
Hydraulic Fluid: Enerpac oil  
115 volt, 1 phase, 50/60 Hz, 20 amp

C

D

### Air/Hydraulic Pump

Part No. 82C-0AP



*(for use with the Minikrimp, Karrykrimp and Karrykrimp 2)*

Lightweight pump operates with 80-110 psi shop air pressure and delivers 10,000 psi

Length: 15"  
Width: 6"  
Height: 6"  
Intake Port Size: 1/4" NPTF  
Output Port Size: 3/8" NPTF  
Weight: 14 lbs  
Hydraulic Fluid: Enerpac oil

### Vehicle Battery-Powered Pump

Part No. 85C-12V



*(for use with the Minikrimp, Karrykrimp and Karrykrimp 2)*

Ideal unit for Parker Mobile Hose Replacement Service, Delivering 10,000 psi.

Length: 12"  
Width: 8"  
Height: 19.5"  
Weight: 67 lbs  
Hydraulic Fluid: ISO-46

E

#### Enerpac Warranty Statement

Enerpac products are warranted to be free of defects in materials and workmanship. Any product that does not conform to specification will be repaired or replaced at Enerpac's expense, anywhere in the world; simple as that! This warranty does not cover ordinary wear and tear, abuse, misuse, alterations, or the use of improper fluids. Determination of the authenticity of a warranty claim will be made only by Enerpac or its Authorized Service Centers.



# www.parker.com/crimpsource

Crimpsource is the industry's most complete resource for crimper technical information. It contains all of the crimp specifications approved for Parker's rubber, industrial and thermoplastic hose:

- Crimp specs
- PDFs of technical manuals for easy downloading
- Parts lists
- Troubleshooting advice
- PDFs of crimper decals for immediate printing

Crimpsource provides easy access to all the specifications necessary to correctly fabricate a factory quality hose assembly.

## Crimpsource Spec Page

A series of dropdown menus enables users to find what they need quickly and easily.

Choose your crimper, and then select the hose, fittings and current specifications needed to make hose assemblies.

You can also print a simple-to-follow data specification sheet or crimper decal.

Print your own crimp decals whenever you need to

## Crimpsource Home Page

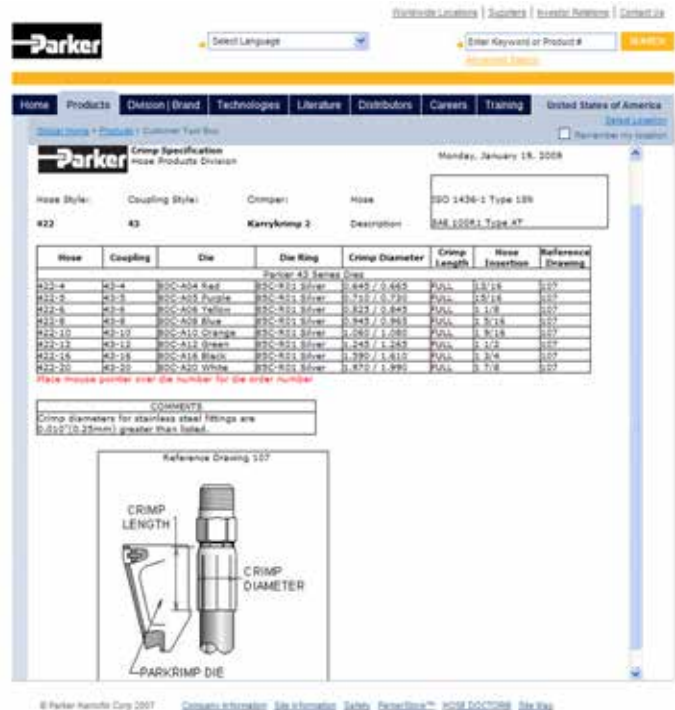
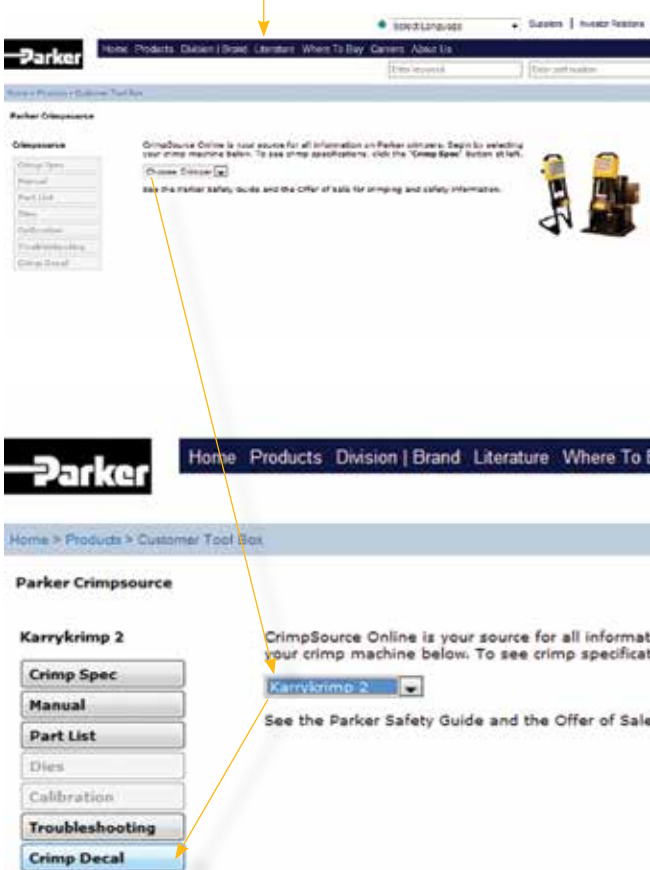

A

B

C

D

E

### Crimping using Minikrimp, Karrykrimp, Karrykrimp Bench Mount, Karrykrimp 2 and Karrykrimp 2 Bench Mount

Parkrimp Fittings Series 25, 26, 43, 70, 71, 73, 76, 78, S6, 81, HY

#### 1 Mark insertion depth and push on fitting

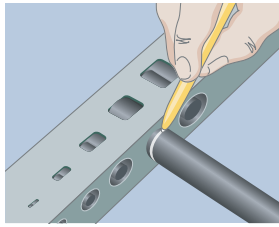

Mark the hose insertion depth and push hose into fitting until the mark on the hose is even with the end of the shell. Lubricate hose if necessary, however, **DO NOT lubricate if using spiral hose.** See Hose Insertion Depth table below.



For 81 Series Shells with 88 Series Fittings

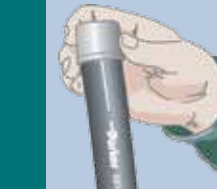

Place shell onto end of hose and make sure the end of the shell lines up with the Insertion Depth mark.

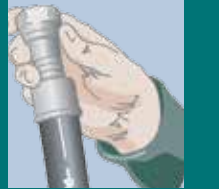

Push hose onto the 88 Series fitting until the shell bottoms against the fitting's stop ring or hex. Lubricate hose if necessary.

#### 2 Insert unitized die train



Pull pin at the top of pusher to swing it back. Place unitized die-train into base plate. See decal on crimpers for proper die set.

**Note: Parkrimp 1 does not have a pin at the top of the pusher.**

**Important:** Lubricate the crimpers die bowl using a premium quality lithium-base grease.

Color-Coded Unitized Die-Train

#### 3 Position the fitting

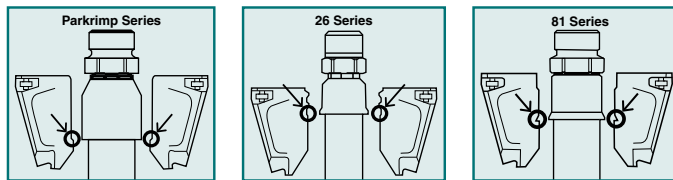

Position the hose and fitting in dies from below. Rest bottom of coupling on die step using the PARKALIGN® feature.

#### 4 Place die ring and crimp



Place correct die ring on top of the dies. See decal on crimpers for proper die ring.

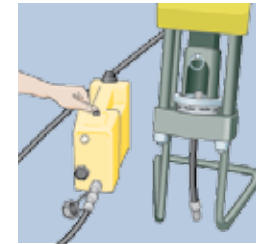

Position pusher by replacing the pin and operate pump until the die ring bottoms out. Release pressure within the pump — remove finished assembly.

**Note:** Minikrimp, Karrykrimp & Karrykrimp 2 have several types of power sources, all of which are separate units from the crimping machine.

#### 5 Measure crimp diameter

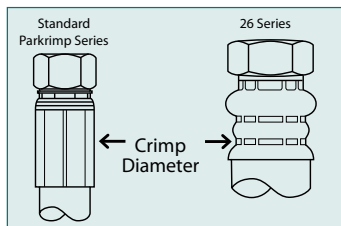

Measure crimp diameter on the flat surfaces of the crimped shell, referenced in the illustration to the left. Reference decal on crimpers for crimp diameters. Never use hose assemblies with incorrect crimp diameters.

**Important:** Hose assemblies must be inspected for cleanliness and free of all foreign particles.

#### Hose insertion depths

Fitting Size	Fitting Series																										
	25		26		43		70		71		73		77		78		S6		79		81		HY				
	inch	mm	inch	mm	inch	mm	inch	mm	inch	mm	inch	mm	inch	mm	inch	mm	inch	mm	inch	mm	inch	mm	inch	mm			
-4	—	—	13/16	21	13/16	21	—	—	—	—	—	—	—	—	—	—	—	—	—	—	—	—	—	—	1-7/16	37	
-5	—	—	13/16	21	15/16	24	—	—	—	—	—	—	—	—	—	—	—	—	—	—	—	—	—	—	—	—	
-6	7/8	22	13/16	21	1-1/8	29	1-1/16	27	1-1/16	27	—	—	—	—	—	—	—	—	—	—	—	—	—	—	—	1-1/2	40
-8	7/8	22	13/16	21	1-5/16	33	1-5/16	33	1-1/4	32	—	—	1.36	34.6	—	—	—	—	—	—	—	—	—	—	—	1-9/16	40
-10	—	—	7/8	22	1-9/16	40	1-3/8	35	1-5/16	33	—	—	1.53	38.9	1-7/8	47	—	—	—	—	—	—	—	—	—	1-9/16	40
-12	—	—	7/8	22	1-1/2	38	1-1/2	38	1-7/16	37	1-7/8	48	1.78	45.2	1-7/8	48	—	—	2-3/16	56	1-1/8	29	1-5/8	40	—	—	40
-16	—	—	1	25	1-3/4	44	1-13/16	46	1-3/4	44	2	51	2.13	54.1	2	51	—	—	2-5/16	59	1-1/4	32	1-3/4	43	—	—	
-20	—	—	1	25	1-7/8	48	1-3/4	44	1-13/16	46	2-1/2	64	2.51	63.8	2-1/2	64	—	—	2-13/16	71	1-5/16	33	—	—	—	—	
-24	—	—	1-1/16	27	1-7/16	37	—	—	2-5/16	59	2-7/16	62	—	—	2-7/16	62	—	—	—	—	—	—	—	—	—	—	—
-32	—	—	1-1/4	32	1-13/16	46	—	—	2-7/16	62	2-13/16	71	—	—	—	—	—	—	3-1/2	88	—	—	—	—	—	—	

For specific information on crimping, visit Crimpsource™ online at [www.parker.com/crimpsource](http://www.parker.com/crimpsource).

### Crimping using Superkrimp and Parkrimp 2

Parkrimp Fittings Series 25, 26, 43, 70, 71, 73, 76, 78, S6, 81, HY

#### 1 Mark insertion depth and push on fitting

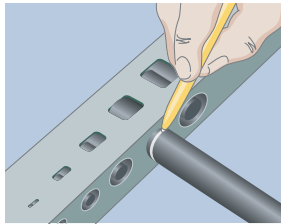

Mark the hose insertion depth and push hose into fitting until the mark on the hose is even with the end of the shell. Lubricate hose if necessary, however, **DO NOT lubricate if using spiral hose.** See Hose Insertion Depth table on previous page.

#### For 81 Series Shells with 88 Series Fittings

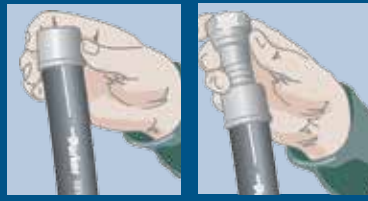

Place 81 Series Shell onto end of hose and make sure the end of the shell lines up with the Insertion Depth mark.

Push hose onto the 88 Series fitting until the shell bottoms against the fitting's stop ring or hex. Lubricate hose if necessary.

#### 2a If using large two-piece dies

Insert the proper die set into the die bowl. (The die sets are in two halves of four dies each. Place one half in the back and one half in the front to accommodate bent tube fittings.) Reference decal on crimper for proper tool selection.

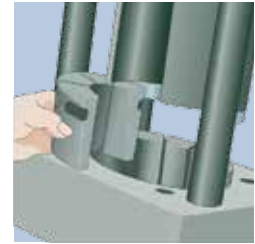

#### 2b If using small unitized dies

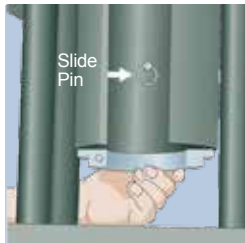

With the pusher in the full up position, lift the back half of the split die ring. Lock it in the up position by pushing the slide pin in. (The slide pin is located inside the pusher at the back.)

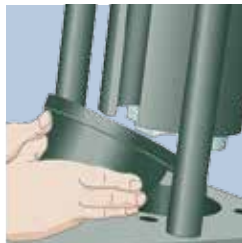

Lubricate die bowl using a premium quality lithium-base grease. Carefully insert the adapter bowl, 83C-OCB, into the base bowl. The adapter bowl must be tilted toward the back of the crimper during insertion.

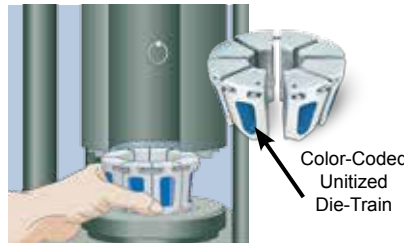

Lubricate die bowl using a premium quality lithium-base grease. Place unitized die-train into the adapter bowl. Select die and die ring by hose size and type. See decal on crimper for proper die set.

**Note:** Die sets have color-coded cavities indicating size and have the fitting series and dash size stamped on the top.

#### 3 Place spacer ring



If required, place spacer ring on locating step of adapter bowl. Reference decal on crimper for tool selection.

#### 4 Position the split die ring



Lower the back half of the split die ring onto the dies by pulling the slide pin forward.

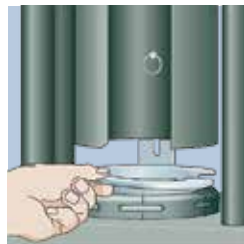

Insert the front half of the split die ring aligning the pins in the back half with the hole in the front half.

#### 5 Position the fitting

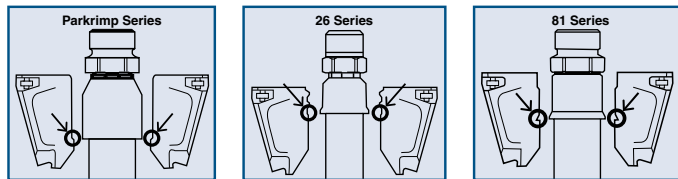

Position the hose and fitting in dies from below. Rest bottom of coupling on die step using the PARKALIGN® feature.

#### 6 Crimp hose

Turn on the pump by pressing the "ON" switch. Pull the valve handle forward to bring the pusher down for crimping. When the split die ring contacts the base plate, the crimp is complete. Push the valve handle back to lift the pusher, open the dies, and release the finished assembly.

**Note:** You do not have to remove any tooling to insert or remove straight fittings. The front half of the split die ring and the front die train must be removed to insert and remove bent tube fittings.



#### 7 Measure crimp diameter

Measure crimp diameter on the flat surfaces of the crimped shell, referenced in the illustration to the right. Reference decal on crimper for crimp diameters. Never use hose assemblies with incorrect crimp diameters.

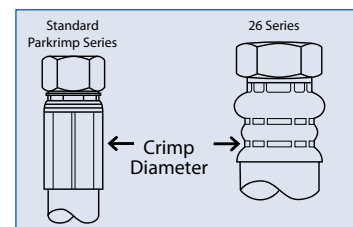

**Important:** Hose assemblies must be inspected for cleanliness and free of all foreign particles.

## Assembling Twin Tough Rubber Hose

A

### Required Equipment:

Twin Tough hose, fittings, knife, tape measure, heat shrink sleeve, scissors, grease pencil, heat gun, and calipers.



B

### Set-up:

Position the bonded rubber hose so that it lies flat on a work surface without tendency to twist or turn.

### Measure hose tear back length:

Measure and mark the length that the hoses are to be separated. A minimum of 12 inches is required for crimping the hose ends. A 24 inch tear back is recommended for use with hydraulic tools.



C

Note: If length of separation/tear back is specified from the threaded or swivel nut end of the coupling, then deduct the cut off allowance dimension for the specific style of coupling used. The cutoff allowance can be obtained from the hose fitting tables in the 4400 Catalog "B" dimension, or can be calculated by subtracting the insertion depth of the shell from the overall coupling length.

### Cut hose tear back to length:

Press the bonded hose assembly firmly and flat against the work surface with your free hand so that it does not move.

A.) Using a sharp blade, pierce the center of the valley (web) formed by the hoses.



B.) To start the cut, place the blade in the center of that valley (web) drawing the knife with constant pressure.



C.) Once you have a 1 to 2 inch starter cut, firmly pull each hose end apart to your required separation length.



E

Note: It is important that the knife blade be perpendicular to the hose during this procedure so the blade cuts only the centerline of the valley (web). EXTREME CARE MUST BE TAKEN TO AVOID CUTTING THROUGH THE COVER OF THE HOSES AND THEREBY EXPOSING THE HOSE REINFORCEMENT. If this occurs, the hose assembly must be discarded.

**Measure Separation:** It is suggested that the separation length be at least 12 inches, so the crimping operation can be accomplished without risk of kinking the hoses.



**Stopping Separation:** Parker recommends installing a heat shrink sleeve of at least 2 inches in length at the termination of the separated hose to provide protection against tearing of the valley (web) or hose covers. This heat shrink sleeve should be placed on the hose assembly prior to the crimping of the hose fittings. Once you have your heat shrink sleeve in place, use a heat gun to shrink the sleeve in place.



Note: EXTREME CARE MUST BE TAKEN TO AVOID EXPOSING THE HOSE ASSEMBLY TO THE DIRECT HIGH TEMPERATURES OF THE HEAT GUN WHILE INSTALLING THE HEAT SHRINK SLEEVE. LONG EXPOSURE FROM A HEAT GUN MAY ADVERSLEY AFFECT THE HOSE INNERTUBE OR ITS COVER.

**Crimping Fittings:** All of your crimping information can be found on Crimpsource ([www.parker.com/crimpsource](http://www.parker.com/crimpsource)).

First, place your fittings onto each hose end making sure that both have been installed to the correct hose insertion depth. Choose the correct die and die ring. Place half of your hose assembly through the bottom of your Parkrimp crimper. Rest the bottom of the fitting on the die step using the Parkalign system. While lightly holding the hose assembly, operate your crimper pump so that the pusher on the crimper comes down in contact with the die ring until it bottoms out on the crimper base. Then release the pressure within the pump and remove the first half of your finished assembly. Always measure your hose assemblies for the correct crimp diameter. Now, repeat the crimping process on the other fitting.



Note: EXTREME CARE MUST BE TAKEN TO AVOID KINKING THE HOSE THAT IS NOT BEING CRIMPED DURING THIS PROCESS.

A



## Hydraulic Press Kit

Part No. 8PC-001

For use with 26, 43, 81 and HY Series Fitting ONLY

### Specifications

- Required Height from Press Base to Press Ram: 10 inches
- Required Width of Bowl Diameter: 5 inches
- Bowl Rating: 30 tons force maximum
- Minimum Required Press Capacity: Hose Size 1/4" to 1/2" needs a 20 ton press  
Hose size 5/8" to 1-1/4" needs a 30 ton press

### Standard Equipment

Part Number	Description	Individual Part Number
8PC-001		
●	Bowl Assembly	8PC-030
●	Pusher	8PC-00P
●	Silver Die Ring	81C-R01
●	Black Die Ring	81C-R02
●	43 Series dies in 1/4", 3/8", 1/2", 3/4" and 1"	80C-Axx

B

## Weatherhead Conversion Kit

Part No. 8WC-001

For use with 26, 43, 81 and HY Series Fitting ONLY

Convert **Weatherhead T-400 crimper** to utilize Parker Parkrimp No-Skive fittings.

### Standard Equipment

Part Number	Description	Individual Part Number
8WC-001		
●	Bowl Assembly	8PC-030
●	Pusher	8WC-00P
●	Silver Die Ring	81C-R01
●	Black Die Ring	81C-R02
●	43 Series Dies in 1/4", 3/8", 1/2" and 3/4"	80C-Axx

C



D

## Gates Conversion Kit

Part No. 8GC-002

For use with 26, 43, 81 and HY Series Fitting ONLY

Convert **Gates 701, 703 and 707 bottom loading crimpers** to utilize Parker Parkrimp No-Skive fittings.

### Standard Equipment

Part Number	Description	Individual Part Number
8GC-002		
●	Bowl Assembly	8PC-030
●	Silver Die Ring	81C-R01
●	Black Die Ring	81C-R02
●	43 Series Dies in 1/4", 3/8", 1/2", 3/4" and 1"	80C-Axx

E



**Notes:**

- For additional information and operating instructions, visit the Parker Hose Products Division website at [www.parkerhose.com](http://www.parkerhose.com).
- For crimping instructions, see pages C-18 and C-19.
- Hose assemblies must be inspected for cleanliness and free of all foreign particles.

## Hose Cut-Off Machine - Karrykut

Part No. 631075



### Features

- Portable saw for cutting on the job
- Unique clamp system spreads hose as it cuts to prevent blade binding
- Cuts multi-braided wire reinforced hose including 4 spiral construction up to 1-1/4" I.D.

### Specifications

- Dimensions: 16" wide x 12" long x 19" high
- Shipping Weight: 58 lbs.

### Standard Equipment

Part Number	Description	Individual Part Number
631075		
●	Power saw with 115volt (13 amp) universal AC motor	631140
●	Universal clamp attachment (can be used with any portable power saw unit having a 5/8" arbor, 7" blade capacity)	631076
●	Cutting blade (7" with 5/8" arbor size)	621102

## Hose Cut-Off Machine

Part No. TH3-51



### Features

- Standard 14" scalloped blade
- Front plate with useable pins easily holds in place for a straight cut
- Clear face shield
- Cuts 1 & 2 wire braid through 2" I.D., 4-wire spiral through 2" I.D., and 6-wire spiral through 1" I.D.

### Specifications

- 4.5 HP/115 volts 20 amp 1PH 50/60 cycle motor (a 20 amp dedicated circuit is recommended)
- Dimensions - 22-1/2" wide x 13" long x 25-1/2" high
- Shipping weight - 67 lbs.
- Blade size - 14" x 0.125" x 1"

### Saw Part Number: TH3-51

- Optional Equipment:
- Scalloped Cutting Blade (TH3-50-1)
- Smooth Bevel Cutting Blade (TH3-50-2)

## Hose Cut-Off Machine

Part No. 332T-115V



### Features

- For quick, easy cutting of spiral reinforced hose up to 1-1/4" I.D.
- Moving parts shielded by guards

### Specifications

- Dimensions: 13" wide x 26" long x 22" high
- Shipping Weight: 71 lbs.

### Standard Equipment

Part Number	Description	Individual Part Number
332T-115V		
●	Hose Cut-Off Machine with 1-1/2 HP, 3450 RPM, 115/230V single phase electric motor wired for 115V	
●	Scalloped Cutting Blade (8" with 5/8" arbor size)	24398

### Optional Equipment

- Smooth Cutting Blade (580661)

## Hose Cut-Off Machine

Part No. 239 and 339



### Features

- Designed for heavy duty use
- Cuts multi-braided wire reinforced hose including 6 spiral construction up to 2" I.D.

### Specifications

- Dimensions: 22" wide x 42" long x 24" high
- Shipping Weight: 115 lbs.

### Standard Equipment

Part Number		Description	Individual Part Number
239	339		
●		Hose Cut-Off Machine with 230V single phase motor	
	●	Hose Cut-Off Machine with 3 HP motor 230V, 3 phase, 60 cycle	
●	●	Scalloped Cutting Blade (10" with 3/4" arbor size)	24248

### Optional Equipment

- Smooth Cutting Blade (15960)

A

B

C

D

E

## Ultra Clean Hose Cleaning Kit

## Economy Hose Cleaning Kit

A



Part No. TH6-10-HL-9-2



Part No. TH6-10-EL-7

B

### Features

- Capable of cleaning 1/4" through 2" hose, tube or pipe
- The launcher is supplied with a Full-Flow Quick Release Coupling and unique 360° Rotary Plug for proper air flow and non-fatigue operator use
- Unique Safety Release Bar that locks the faceplate into a closed position for firing Ultra Clean projectiles

### Air Requirements:

- 80 PSI (5.5 Bar) minimum to 110 PSI (7.5 Bar) maximum
- 1/2" I.D. air hose
- 5 micron filter and regulator with gauge are strongly suggested



C

### Economy Kit Features

- Capable of cleaning 1/4" through 1-1/4" hose, tube or pipe
- Has a quarter-turn locking ring for easy nozzle change and projectile loading
- The launcher is constructed of durable brass and aluminum internals, strong plastic handle, and anodized aluminum firing head and locking ring.
- Ideal for mobile and job site applications because of its size and portability

### Air Requirements:

- 80 PSI (5.5 Bar) minimum to 110 PSI (7.5 Bar) maximum
- 1/2" I.D. air hose
- 5 micron filter and regulator with gauge are strongly suggested

D

### Optional Equipment & Accessories:

- A range of projectiles are available enabling the Ultra Clean System to be used on different sizes and types of hose, as well as coupling configurations
- Additional nozzles for JIC, Code 61 and Code 62 flanges, and ORFS are also available if required

E



# Ultra Clean Hose Cleaning Kit

## Sizing Chart and Part Numbers

HOSE ONLY		
Hose Size	Nozzle Part Number	Projectile Part Number
3/16"	TH6-10-H06	TH6-10-P06
1/4"	TH6-10-H06	TH6-10-P10
3/8"	TH6-10-H10	TH6-10-P14
1/2"	TH6-10-H13	TH6-10-P18
5/8"	TH6-10-H16	TH6-10-P22
3/4"	TH6-10-H19	TH6-10-P26
1"	TH6-10-H25	TH6-10-P33
1-1/4"	TH6-10-H32	TH6-10-P40
1-1/2"	TH6-10-H38	TH6-10-P50
2"	TH6-10-H50	TH6-10-P60

HOSE ASSY W/FJIC		
FJIC Size	Nozzle Part Number	Projectile Part Number
1/4"	TH6-10-J06	TH6-10-P06
3/8"	TH6-10-J10	TH6-10-P12
1/2"	TH6-10-J13	TH6-10-P16
5/8"	TH6-10-J16	TH6-10-P22
3/4"	TH6-10-J19	TH6-10-P26
1"	TH6-10-J25	TH6-10-P33
1-1/4"	TH6-10-J32	TH6-10-P40
1-1/2"	TH6-10-J38	TH6-10-P50
2"	TH6-10-J50	TH6-10-P60

HOSE ASSY W/FFORX		
FFORX Size	Nozzle Part Number	Projectile Part Number
1/4"	TH6-10-4FFORX	TH6-10-P06
3/8"	TH6-10-H06	TH6-10-P12
1/2"	TH6-10-H10	TH6-10-P16
5/8"	TH6-10-H13	TH6-10-P22
3/4"	TH6-10-H16	TH6-10-P26
1"	TH6-10-H19	TH6-10-P33
1-1/4"	TH6-10-H25	TH6-10-P40

HOSE ASSY W/Code 61 & 62 Flanges		
Flange Size	Nozzle Part Number	Projectile Part Number
1/2"	TH6-10-H10	TH6-10-P16
3/4"	TH6-10-H16	TH6-10-P26
1"	TH6-10-H19	TH6-10-P33
1-1/4"	TH6-10-H25	TH6-10-P40
1-1/2"	TH6-10-H32	TH6-10-P50
2"	TH6-10-H38	TH6-10-P60

PROJECTILE QUANTITIES		
Parker Part Number	Description	Qty.
TH6-10-P06	PROJECTILE 3/16"	100 PER BAG
TH6-10-P10	PROJECTILE 1/4"	100 PER BAG
TH6-10-P12	PROJECTILE 1/4" AND 5/16"	100 PER BAG
TH6-10-P14	PROJECTILE 3/8"	100 PER BAG
TH6-10-P16	PROJECTILE 3/8"	100 PER BAG
TH6-10-P18	PROJECTILE 1/2"	100 PER BAG
TH6-10-P22	PROJECTILE 5/8"	50 PER BAG
TH6-10-P26	PROJECTILE 3/4"	50 PER BAG
TH6-10-P33	PROJECTILE 1"	40 PER BAG
TH6-10-P40	PROJECTILE 1-1/4"	30 PER BAG
TH6-10-P50	PROJECTILE 1-1/2"	20 PER BAG
TH6-10-P60	PROJECTILE 2"	15 PER BAG



A

## Hose Cut-Off Tool - Handykut

Part No. 871522



### Features

- Portable tool for efficient cutting of hose
- Can be positioned onto a flat surface by clamps or by locking it in a vise, properly align the hose in a radius and cut it with a hacksaw

### Specifications

- Dimensions: 6" wide x 18" long x 6" high
- Shipping Weight: 10 lbs.

B

## Push-Lok Cut-Off & Assembly Tool

Part No. 881540



### Features

- Combined hose cutter and toggle action press that cuts and assembles Parker Push-Lok in sizes 1/4" through 3/4" I.D.

### Specifications

- Dimensions: 16" long
- Shipping Weight: 4 lbs.

C

## Hose Insertion Depth Blocks

Part No. TH9-1-XXX



### Features

- For quick easy marking of hose insertion depth
- Ensures accuracy and increased productivity

### Available Blocks

Part Number	Description
TH9-1-26A	26 Series -4 through -10
TH9-1-26B	26 Series -12 through -32
TH9-1-43A	43 Series -4 through -10
TH9-1-43B	43 Series -12 through -32
TH9-1-70	70 Series -6 through -20
TH9-1-71	71 Series -6 through -32
TH9-1-73	73 Series -12 through -32
TH9-1-77	77 Series -8 through -16
TH9-1-78	78 Series -12 through -32
TH9-1-79	79 Series -12 through -24
TH9-1-HY	HY Series -4 through -16

D

## Hose Cut-Off Tool

Part No. TH11-1



### Features

- Designed for quick, easy cutting of textile reinforced hose.
- Squarely cuts Push-Lok hose in sizes 1/4" through 3/4" I.D.

### Specifications

- Dimensions: 8" long
- Shipping Weight: 0.3 lbs.

E

## Hozemblem

Part No. 432-115V



### Features

- Power machine to facilitate the attachment of field attachable fittings
- Handles all hose and fittings up to 4 spiral wire, in sizes 3/16" through 2" I.D., including bent tube elbows
- Comes with vise, all adapters, foot switch and safety guard with 115V, 30 amp, universal AC motor

### Specifications

- Shipping Weight: 141 lbs.

### Optional Parts

- Mounting stand (662451)

## Die Storage Racks

Part No. 80C-0DR and 83C-0DR



### Features

- Modular die rack designed to hold small and large Parkrimp dies
- Can be bolted together to a work bench horizontally or vertically

### Standard Equipment

Part Number		Description
80C-0DR	83C-0DR	
●		Storage of three sets of small dies
	●	Storage of two sets of large dies

A

B

C

D

E

## Swivel Die Rack

Part No. 80C-SDR-XXXX



### Features

- Holds up to 30 Parkrimp dies of any size
- Powder-coated, heavy-duty steel construction
- Consists of a base unit and up to five circular holders
- Floor or bench mounted

### Standard Equipment

Part Number	Description
80C-SDR-SM	Swivel Die Rack and Small Die Holder
80C-SDR-LG	Swivel Die Rack and Large Die Holder
80C-SDR-BASE	Swivel Die Rack Base

## Fitting Push-On Stand

Part No. TH2-7



### Features

- Quickly and easily pushes fittings onto hose
- Boosts productivity and quality
- Eliminates the need of rubber mallets and oils to get fittings onto the end of the hose for crimping
- Standard with straight tooling required for sizes 1/4" through 2" for all crimped fittings, 82 Series Push-Lok and 88 Series field attachable fittings

### Specifications

- Shipping Weight: 200 lbs.

### Optional Tooling

- Elbow Pusher Set (TH2-7-ELS)

A

### Mandrel Tool Kit - 22 Series

Part No. 652200



#### Features

- For assembly of Parker 22 Series field attachable fittings
- One of each part listed below is included in the kit

#### Standard Equipment

Hose I.D.	Dash Size	SAE (JIC) 37°	SAE 45°
3/16	-4	●	●
1/4	-5	●	●
5/16	-6	●	●
13/32	-8	●	●
1/2	-10	●	●
5/8	-12	●	●

B

C

D

E

### Mandrel Tool Kit - 23 Series

Part No. 2727 and 2726



#### Features

- For assembly of Parker 23 Series field attachable fittings
- Part No. 2727 is for JIC 37° flared fittings
- Part No. 2726 is for SAE 45° and PTT 30° flared fittings

#### Standard Equipment

Hose I.D.	Dash Size	2727	2726
3/16	-4	●	●
1/4	-5	●	●
5/16	-6	●	●
13/32	-8	●	●
1/2	-10	●	●
5/8	-12	●	●
7/8	-16	●	●

### Mandrels - 25 Series

(For 271 Transportation Hose)

Part No. TH2-7M25-6 and TH2-7M25-8



### Assembly Tools - 22 Series

Part No. 652201



#### Features

- For assembly of Parker 22 Series field attachable fittings
- One of each part listed below is included in the kit

#### Standard Equipment

Hose I.D.	Dash Size	SAE (JIC) 37°	SAE 45°
7/8	-16	●	●
1-1/8	-20	●	●
1-3/8	-24	●	●
1-13/16	-32	●	●

## Hose Perforator

Part No. 601069



### Features

- Small hand tool to prick minute holes in the rubber cover
- To be used in gaseous applications where the pressure exceeds 250 psi
- Driven into the cover every few inches of length either striking the hose or by a rolling action over the hose cover
- Not generally necessary to perforate the hose on all sides

### Specifications

- Shipping Weight: 2 lbs.

## Hose Oil

Part No. Hose Oil



### Features

- Reduces torque and eliminates waste lubrication
- Use hose oil with the recommended hose assembly instructions

A

B

C

D

E

## Accrolube

Part No. Accrolube



### Features

- High efficiency lubricant used for stainless steel field attachable fittings
- Contains Teflon to reduce the wear between metal surfaces, protects against corrosion and ultimately eliminates galling

## Small Crimper Hood

Part No. 82C-CVR



### Features

- Water repellent
- UV protected
- Perfect for indoor and outdoor applications

### Fits

- Karrykrimp, Parkrimp  
Karrykrimp2, Minikrimp

## Large Crimper Hood

Part No. 83C-CVR



### Features

- Water repellent
- UV protected
- Perfect for indoor and outdoor applications

### Fits

- PHastkrimp, Superkrimp  
Parkrimp2

A

B

C

D

E