



aerospace
climate control
electromechanical
filtration
fluid & gas handling
hydraulics
pneumatics
process control
sealing & shielding



Quick Coupling Products

Quick Couplings, Swivels, Valves,
Diagnostic Equipment
Catalog 3800 USA | February 2014



ENGINEERING YOUR SUCCESS.

Table of Contents

Introduction	B-1
Coupling Selection & Ordering Guide	B-3, 4
General Purpose Couplings	
60 Series.....	B-5
Couplers.....	B-7, 8
Nipples.....	B-7, 8
60 Series Steam	B-10
Couplers.....	B-10
Nipples.....	B-10
6600 Series.....	B-11
Couplers.....	B-12
Nipples.....	B-12
H Series	B-14
H Couplers	B-17, 18, 19
H Nipples	B-20, 21, 22
PH Couplers.....	B-19
PH Nipples	B-23
EA Series	B-24
Couplers.....	B-26
Nipples.....	B-27
SM Series.....	B-28
Couplers.....	B-29
Nipples.....	B-29
HP Series.....	B-31
Couplers.....	B-32
Nipples.....	B-32
4000 Series.....	B-33
Couplers.....	B-34
Nipples.....	B-34
4200 Series.....	B-36
Couplers.....	B-37
Nipples.....	B-37
Non-Spill Couplings	
NS Series.....	B-38
Couplers.....	B-39
Nipples.....	B-39
EAS/SAE Adapters.....	B-40
FF/FC Series.....	B-41
Couplers.....	B-42
Nipples.....	B-42
FC Nipples.....	B-44
FEM/FEC Series.....	B-45
Couplers	B-46
Nipples.....	B-47
FEC Nipples	B-48
FH Series.....	B-49
Couplers	B-50
Nipples.....	B-50
FS Series	B-51
Couplers	B-52
Nipples.....	B-52
Repair Kits	B-53

Connect Under Pressure Couplings	
FET Series.....	B-54
Couplers.....	B-55
Nipples.....	B-56
6100 Series.....	B-58
Couplers	B-59, 60
Nipples.....	B-60
8200 Series.....	B-61
Couplers	B-62
Nipples.....	B-62
9200 Series.....	B-63
Couplers	B-64
Nipples.....	B-64
5000 Series.....	B-65
Couplers	B-66
Nipples.....	B-66
75 Series	B-67
Couplers.....	B-69
Nipples.....	B-69
High Pressure Couplings	
71 Series	B-70
Couplers.....	B-72
Nipples.....	B-73
3000 Series.....	B-74
Couplers	B-75
Nipples.....	B-75
TC Series	B-76
Couplers	B-76
Nipples.....	B-76
1141 Series.....	B-77
Couplers	B-77
Nipples.....	B-77
High Flow Couplings	
ST Series	B-78
Couplers	B-79
Nipples.....	B-80
1163 Series.....	B-81
Couplers	B-81
Nipples.....	B-81
HO Series	B-82
Couplers	B-82
Nipples.....	B-82
Mold Coolant Line Couplings	
Moldmate Series.....	B-83
Couplers	B-84, 85
Sub Assemblies & Replacement Parts.....	B-85
Nipples.....	B-87, 88
Special Purpose - Miniature	
DM Series.....	B-89
Couplers	B-90
Nipples.....	B-90
Ordering Information and Options	B-91
Promotional Products-Keychains	B-92



Hydraulic Coupling Selection Guide

Body Sizes (in.)	Valving Style	Material						Locking Mechanism	Std Seal Material*	Std Seal Temp Range	Rated Pressure	Coupling Series
		A	B	S	S3	S6	HP					
General Purpose												
1/8 to 2-1/2	Poppet		■	■	■	■		Ball	Nitrile	-40° to +250° F	800-5000 psi	60 Series
1/4 to 1	Poppet		■					Ball	Ethylene Propylene	-65° to +400° F		60 Series (steam)
1/4 to 1	Poppet		■	■				Ball	Nitrile	-40° to +250° F	4000-5000 psi	6600 Series
1/4 to 4	Poppet/Unvalved	■	■	■		■		Ball	Nitrile	-40° to +250° F	150 - 11000 psi	H Series
1/4 to 3/4	Valved/Unvalved		■	■		■		Ball	Nitrile	-40° to +250° F	vacuum - 3000 psi	EA Series
1/4 to 3/4	Poppet		■	■				Ball	Nitrile	-40° to +250° F	4500-6000 psi	SM Series
1 to 1-1/2	Poppet		■	■				Ball	Nitrile	-40° to +250° F	5000 psi	HP Series
1/4 to 1	Poppet/Ball		■	■				Ball	Nitrile	-40° to +250° F	3000 psi	4000 Series
3/8 to 1/2	Poppet/Ball		■	■				Ball	Nitrile	-40° to +250° F	3000 psi	4200 Series
Non-Spill												
3/8 to 1	Flush Face		■	■				Ball	Nitrile	-40° to +250° F	2500 psi	NS Series
1/2	Flush Face/Poppet		■	■				Ball	Nitrile/Polyurethane	-40° to +250° F	3000-3625 psi	EAS/SAE Adapters
1/4 to 1	Flush Face		■	■				Ball	Nitrile/Polyurethane	-40° to +250° F	3000-5000 psi	FF Series
1/4 to 1	Flush Face		■	■				Ball	Nitrile/Polyurethane	-40° to +250° F	3000-5000 psi	FEM Series
1/4 to 1	Flush Face		■	■		■		Ball	Fluorocarbon	-15° to +400° F	2000 psi	FS Series
Non-Spill Connect Under Pressure												
3/8 to 1-1/2	Flush Face		■	■				Threads	Nitrile/Polyurethane	-40° to +250° F	6000 psi	FET Series
3/8 to 3/4	Flush Face		■	■				Ball	Nitrile/Polyurethane	-40° to +250° F	3000 psi	FC Series
1/2 to 3/4	Flush Face		■	■				Ball	Nitrile/Polyurethane	-40° to +250° F	3000 psi	FEC Series
3/4 to 1-1/2	Flush Face		■	■				Threads	Nitrile	-40° to +250° F	2000-3000 psi	6100 Series
Connect Under Pressure												
1/2	Poppet		■	■				Ball	Nitrile	-40° to +250° F	3000 psi	8200 Series
1/2	Poppet		■	■				Ball	Nitrile	-40° to +250° F	3000 psi	9200 Series
1/2	Ball		■	■				Threads	Nitrile	-40° to +250° F	2500 psi	5000 Series
3/4 to 4	Poppet		■	■		■		Threads	Nitrile	-40° to +250° F	5000 psi	75 Series
High Pressure												
1/4 to 2	Flush Face		■	■		■	■	Ball	Nitrile	-40° to +250° F	10,000 ps	71 Series
3/8	Flush Face		■	■				Ball	Nitrile	-40° to +250° F	10,000 psi	FH Series
1/4 to 3/8	Ball		■	■				Threads	Polyurethane	-22° to +230° F	10,000 psi	3000 Series
3/8	Poppet		■	■				Ball	Fluorocarbon	-15° to +400° F	10,000 psi	TC Series
1/4	Poppet		■	■		■		Threads	Polyurethane	-22° to +230° F	10,000 psi	1141 Series
High Flow												
1/8 to 1-1/2	Unvalved		■	■	■			Ball	Nitrile	-40° to +250° F	2500-6700 psi	ST Series
1/4 to 1/2	Unvalved		■	■				Ball	Nitrile	-40° to +250° F	10,000-15,000 psi	H0 Series
3/4	Unvalved		■	■				Ball	Nitrile	-40° to +250° F	200 psi	1163 Series
Mold Coolant												
1/4 to 1/2	Valved/Unvalved		■	■				Ball	Silicone	-20° to +400° F	200 psi	Moldmate
Miniature												
1/8	Poppet		■	■				Ball	Fluorocarbon	-15° to +400° F	250 psi	DM Series

Materials:

A - Aluminum

B - Brass

S - Steel

S3 - 303 Stainless

S6 - 316 Stainless

HP - High Pressure Stainless Steel





60 Series double shut-off couplings are versatile for use across a spectrum of hydraulic applications where fluid lines require connection and disconnection. Couplers and nipples are available in a wide range of sizes and materials.

Features:

- Accepts ISO 7241-1, Series B compliant nipples
- Poppet valves along with a metal to metal valve stop maintains valve alignment and prevents flow checking
- Steel, brass, and stainless steel material options
- Brass couplers have double O-rings and stainless steel locking balls
- Steel coupler sleeve and steel nipple body are hardened to be wear resistant
- Standard end configurations include female pipe and straight thread ORB
- Optional Sleeve-Lok and alternative seal materials available

Applications include:

- Industrial hydraulic lines
- Food and chemical processing
- Water and coolant lines
- Mobile equipment
- May be used with some gases

General Purpose Specifications																	
Industry Standard: Parker 60 Series couplings comply with ISO 7241 Series B Standard.																	
ANSI/ISO Pressure Rating: Dynamic applications with normal to moderate hydraulic shocks such as general industrial equipment, hydraulic presses, agricultural equipment, etc. Impulse tested at a multiple (125% to 133%) of rated pressure.									Low Cycle, Non-pulsating Pressure Rating: Applications with lower cycle life and no severe cyclic pressure fluctuations, essentially steady pressure during an operating cycle. Typical applications include hydraulic jacks, mine roof support systems, and high pressure fluid transfer (pumping water or slurry in oil wells). Minor pump ripple is considered non-pulsating. Impulse tested at rated pressure.								
Body Size	1/8	1/4	3/8	1/2	3/4	1	1 1/2	2 1/2	1/8	1/4	3/8	1/2	3/4	1	1 1/2	2 1/2	
	Rated Pressure (psi)								Rated Pressure (psi)								
Brass	1000	1000	1000	1000	1000	1000	800	800	3000	3700	2700	3500	2200	1500	1500	1200	
Stainless steel	2000	2000	1500	1500	1500	1000	1000	1000	5000	5000	5000	5000	3000	3000	1500	1500	
Steel	5000	5000	4000	4000	2500	2000	1000	1000	5000	5000	4000	4000	2500	2000	1500	1500	
Steel w/ HD nipple	N/A	5000	4000	4000	3000	3000	N/A	N/A	5000	5000	4000	4000	3000	3000	N/A	N/A	
Seal Temperature Range: Nitrile: -40°F to +250°F (Standard seal for Brass, Steel, & 303 Stainless Steel couplings). Fluorocarbon: -15°F to +400°F (Standard seal for 316 Stainless Steel couplings). Other Seal materials: Contact the Division for availability.																	
Vacuum Data: 27.4 inches Hg (-0.9 Bar) both connected and disconnected. (1-1/2" and 2-1/2" body size 60 Series couplings are not recommended for service in disconnected mode)																	

Body Size	1/8	1/4	3/8	1/2	3/4	1	1 1/2	2 1/2
Rated Flow (gpm)	.8	3	6	12	28	50	100	200



Performance

B Hydraulics

60 Series (1/8" & 1/4")
Test Fluid: Oil - 150 SUS

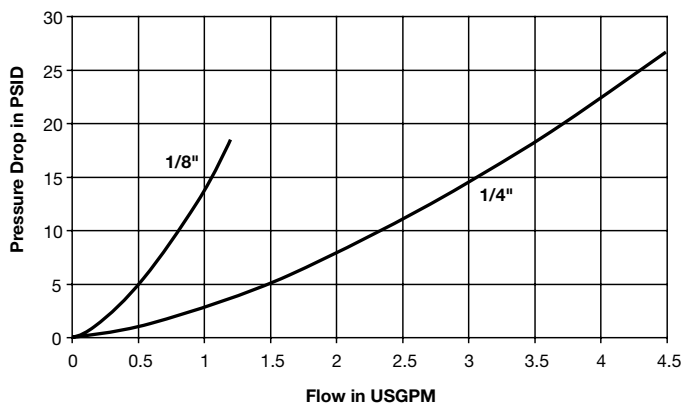

60 Series (3/8" & 1/2")
Test Fluid: Oil - 150 SUS

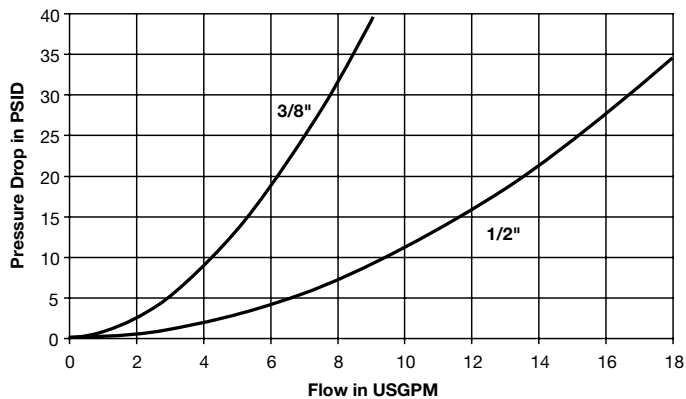

60 Series (3/4" & 1")
Test Fluid: Oil - 150 SUS

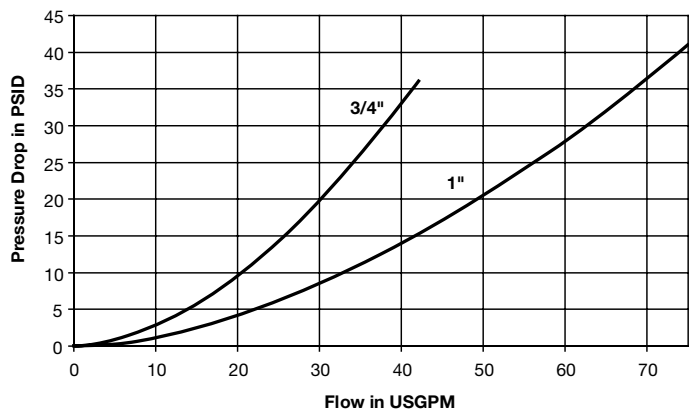

60 Series (1-1/2" & 2-1/2")
Test Fluid: Oil - 200 SUS

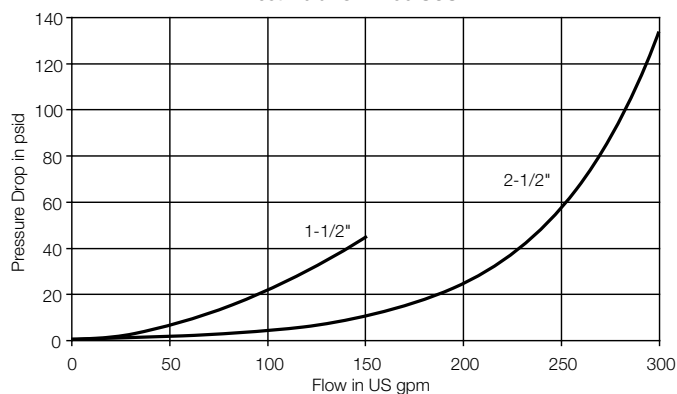



Couplers - Female Thread



Body Size	Part No. Brass	Weight (lbs.)	Part No. Steel	Weight (lbs.)	Part No. Type 303 Stainless	Weight (lbs.)	Part No. Type 316 Stainless	Weight (lbs.)	Thread Size	Overall Length	Wrench Flats	Largest Diameter
1/8	BH1-60	0.16	H1-62	0.16	SH1-62	0.16	SSH1-62Y	0.15	1/8-27 NPTF	1.90	0.68	0.96
1/8	-	-	H1-62-T4	0.18	SH1-62-T4	0.10	SSH1-62Y-T4	0.17	7/16-20 ORB	2.06	0.68	0.96
1/4	BH2-60	0.32	H2-62	0.30	SH2-62	0.30	SSH2-62Y	0.30	1/4-18 NPTF	2.26	0.81	1.14
1/4	-	-	H2-62-T6	0.31	SH2-62-T6	0.31	SSH2-62Y-T6	0.31	9/16-18 ORB	2.41	0.81	1.14
3/8	BH3-60	0.43	H3-62	0.40	SH3-62	0.40	SSH3-62Y	0.40	3/8-18 NPTF	2.49	0.88	1.40
3/8	-	-	H3-62-T8	0.51	SH3-62-T8	0.51	SSH3-62Y-T8	0.51	3/4-16 ORB	2.75	1.00	1.40
1/2	BH4-60	0.80	H4-62	0.73	SH4-62	0.75	SSH4-62Y	0.76	1/2-14 NPTF	2.87	1.12	1.77
1/2	-	-	H4-62-T10	0.78	SH4-62-T10	0.75	SSH4-62Y-T10	0.78	7/8-14 ORB	3.05	1.12	1.77
3/4	BH6-60	1.31	H6-62	1.30	SH6-62	1.31	SSH6-62Y	1.33	3/4-14 NPTF	3.56	1.31	2.14
3/4	-	-	H6-62-T12	1.39	SH6-62-T12	1.34	SSH6-62Y-T12	1.40	1-1/16 - 12 ORB	3.56	1.31	2.14
1	BH8-60	1.95	H8-62	1.95	SH8-62	1.95	SSH8-62Y	1.95	1 - 11 1/2 NPTF	4.18	1.62	2.52
1	-	-	H8-62-T16	1.95	SH8-62-T16	1.95	SSH8-62Y-T16	1.95	1-5/16 - 12 ORB	4.18	1.62	2.52

Nipples - Female Thread



Body Size	Part No. Brass	Weight (lbs.)	Part No. Steel	Weight (lbs.)	Part No. Type 303 Stainless	Weight (lbs.)	Part No. Type 316 Stainless	Weight (lbs.)	Thread Size	Overall Length	Exposed Length*	Wrench Flats	Largest Diameter
1/8	BH1-61	0.04	H1-63	0.03	SH1-63	0.03	SSH1-63Y	0.04	1/8-27 NPTF	1.26	0.44	0.56	0.65
1/8	-	0.06	H1-63-T4	0.05	SH1-63-T4	-	SSH1-63Y-T4	0.06	7/16-20 ORB	1.41	0.59	0.69	0.78
1/4	BH2-61	0.09	H2-63	0.08	SH2-63	0.08	SSH2-63Y	0.08	1/4-18 NPTF	1.54	0.55	0.75	0.87
1/4	-	0.11	H2-63-T6	0.10	SH2-63-T6	0.10	SSH2-63Y-T6	0.10	9/16-18 ORB	1.69	0.70	0.88	1.01
3/8	BH3-61	0.10	H3-63	0.12	SH3-63	0.12	SSH3-63Y	0.12	3/8-18 NPTF	1.68	0.54	0.88	1.01
3/8	-	0.12	H3-63-T8	0.16	SH3-63-T8	0.16	SSH3-63Y-T8	0.14	3/4-16 ORB	1.94	0.80	1.00	1.15
1/2	BH4-61	0.25	H4-63	0.24	SH4-63	0.24	SSH4-63Y	0.24	1/2-14 NPTF	1.94	0.69	1.12	1.30
1/2	-	0.28	H4-63-T10	0.27	SH4-63-T10	0.27	SSH4-63Y-T10	0.27	7/8-14 ORB	2.12	0.87	1.19	1.37
3/4	BH6-61	0.50	H6-63	0.46	SH6-63	0.45	SSH6-63Y	0.46	3/4-14 NPTF	2.43	0.79	1.38	1.59
3/4	-	0.55	H6-63-T12	0.46	SH6-63-T12	0.50	SSH6-63Y-T12	0.50	1-1/16 - 12 ORB	2.54	0.90	1.34	1.59
1	BH8-61	0.76	H8-63	0.76	SH8-63	0.76	SSH8-63Y	0.76	1 - 11 1/2 NPTF	2.91	0.99	1.62	1.88
1	-	0.80	H8-63-T16	0.80	SH8-63-T16	0.80	SSH8-63Y-T16	0.80	1-5/16 - 12 ORB	2.91	0.99	1.62	1.88

* This dimension represents the portion that is exposed when the nipple is inserted into the mating Parker Coupler.



Couplers - Female Thread



Body Size	Part No. Brass	Weight (lbs.)	Part No. Steel	Weight (lbs.)	Part No. Type 303 Stainless	Weight (lbs.)	Part Number Type 316 Stainless	Weight (lbs.)	Thread Size	Overall Length	Wrench Flats	Largest Diameter
1-1/2	BH12-60L	4.58	H12-62L	4.70	SH12-62L	4.68	SSH12-62LY	4.68	1-1/4 - 11 1/2 NPTF	4.86	2.38*	3.00
1-1/2	BH12-60N	4.58	H12-62N	4.70	SH12-62N	4.68	SSH12-62NY	4.68	1-1/2 - 11 1/2 NPTF	4.86	2.38*	3.00
1-1/2	-	4.61	H12-62-T20	4.72	SH12-62-T20	4.71	SSH12-62Y-T20	4.71	1-5/8 - 12 ORB	4.86	2.38*	3.00
1-1/2	-	4.61	H12-62-T24	4.72	SH12-62-T24	4.71	SSH12-62Y-T24	4.71	1-7/8 - 12 ORB	4.86	2.38*	3.00
2-1/2	BH2016-60	11.06	H2016-62	10.58	SH2016-62	-	SSH2016-62Y	-	2 - 11 1/2 NPTF	5.57	3.75	4.10
2-1/2	BH2020-60	11.42	H2020-62	10.91	SH2020-62	-	SSH2020-62Y	-	2 1/2 - 8 NPTF	6.04	3.75	4.10
2-1/2	BH2024-60	-	H2024-62	-	SH2024-62	-	SSH2024-62Y	-	3 - 8 NPTF	6.69	4.00	4.35

*Wrench Flat on 303 Stainless is 2.50 in.

Nipples - Female Thread



Body Size	Part No. Brass	Weight (lbs.)	Part No. Steel	Weight (lbs.)	Part No. Type 303 Stainless	Weight (lbs.)	Part No. Type 316 Stainless	Weight (lbs.)	Thread Size	Overall Length	Exposed Length*	Wrench Flats	Largest Diameter
1-1/2	BH12-61L	2.96	H12-63L	3.10	SH12-63L	3.06	SSH12-63LY	-	1-1/4 - 11 1/2 NPTF	4.76	2.69	2.38‡	2.75†
1-1/2	BH12-61N	2.96	H12-63N	3.10	SH12-63N	3.06	SSH12-63NY	-	1-1/2 - 11 1/2 NPTF	4.76	2.69	2.38‡	2.75†
1-1/2	-	-	H12-63-T20	3.15	SH12-63-T20	3.14	SSH12-63Y-T20	-	1-5/8 - 12 ORB	4.76	2.69	2.38‡	2.75†
1-1/2	-	-	H12-63-T24	3.15	SH12-63-T24	3.14	SSH12-63Y-T24	-	1-7/8 - 12 ORB	4.76	2.69	2.38‡	2.75†
2-1/2	BH2016-61	7.78	H2016-63	7.90	SH2016-63	7.92	SSH2016-63Y	-	2 - 11 1/2 NPTF	5.48	2.90	3.75	4.10
2-1/2	BH2020-61	8.12	H2020-63	8.16	SH2020-63	8.16	SSH2020-63Y	-	2-1/2 - 8 NPTF	5.95	3.37	3.75	4.10
2-1/2	BH2024-61	-	H2024-63	-	SH2024-63	-	SSH2024-63Y	-	3 - 8 NPTF	6.87	4.29	4.00	4.35

* This dimension represents the portion that is exposed when the nipple is inserted into the mating Parker Coupler.

† Largest diameter on Brass is 2.96" across Hex Corners

‡ Hex on 303 Stainless is 2.50 in.

Optional Materials and Features:

(add code to part number)

Code	Description	Part Number Example
suffix -VA	Valve actuator (Nipples)	H3-63-VA
suffix -SL	Sleeve-Lok (Couplers)	H3-62-SL
prefix HD	Heavy duty (Steel Nipples)	HDH3-63
suffix W	Ethylene Propylene seal material (EPR)	H3-63W
suffix Y	Fluorocarbon seal material	H3-62Y
suffix Z	Neoprene seal material	H3-63Z

Contact QCD for availability and additional options.

To select proper seal materials, see Fluid Compatibility Chart or contact QCD.



Replacement Parts		
60 Series Couplers		
Body Size	O-Rings - Nitrile	Back-Up Rings
1/8	50001-013-0010	H67A-28
1/4	50001-015-0010	H67C-28
3/8	50001-116-0010	4118007
1/2	50001-213-0010	4128002
3/4	50001-218-0010	4148001
1	50001-222-0010	4158001
1-1/2	50001-124-0010 (Valve)	
1-1/2	50001-138-0260 (Fitting)	
1-1/2	50001-224-0010 (Body 2 req.)	
2-1/2	50001-133-0010 (Valve)	
2-1/2	50001-234-0260 (Fitting)	
2-1/2	50001-333-0010 (Body)	

Repair Kits				
Couplers			Nipples	
Body Size	Repair Kit Part No.	Used for Part No.	Repair Kit Part No.	Used for Part No.
3/8	H67E-62K	H3-62	H67E-63K	H3-63
3/8	BH67E-60K	BH3-60	BH67E-61K	BH3-61
3/8	SH67E-62K	SH3-62	SH67E-63K	SH3-63
3/8	SSH67-62KY	SSH3-62Y	SSH67E-63KY	SSH3-63Y
1/2	H67F-62K	H4-62	H67F-63K	H4-63
1/2	BH67F-60K	BH4-60	BH67F-61K	BH4-61
1/2	SH67F-62K	SH4-62	SH67F-63K	SH4-63
1/2	SSH67F-62KY	SSH4-62Y	SSH67F-63KY	SSH4-63Y
3/4	H67G-62K	H6-62	H67G-63K	H6-63
3/4	BH67G-60K	BH6-60	BH67G-61K	BH6-61
3/4	SH67G-62K	SH6-62	SH67G-63K	SH6-63
3/4	SSH67G-62KY	SSH6-62Y	SSH67G-63KY	SSH6-63Y
1	H67J-62K	H8-62	H67J-63K	H8-63
1	BH67J-60K	BH8-60	BH67J-61K	BH8-61
1	SH67J-62K	SH8-62	SH67J-63K	SH8-63
1	SSH67J-62KY	SSH8-62Y	SSH67J-63KY	SSH8-63Y

60 Series Dust Plugs and Caps				
Body Size	Coupler Dust Plug Aluminum	Coupler Dust Plug Rubber	Nipple Dust Cap Aluminum	Nipple Dust Cap Rubber
1/8	H1-65	H1-65M	H1-66	H1-66M
1/4	H2-65	H2-65M	H2-66	H2-66M
3/8	H3-65	H3-65M	H3-66	H3-66M
1/2	H4-65	H4-65M	H4-66	H4-66M
3/4	H6-65	H6-65M	H6-66	H6-66M
1	H8-65	H8-65M	H8-66	H8-66M
1-1/2	H12-65	-	H12-66	-
2-1/2	H20P-65	-	H20P-66	-



Hydraulic Quick Couplings

General Purpose

60 Series (Steam)

ISO 7241, Series B

Manual sleeve, EP seal

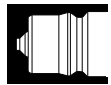

60 Series Steam couplings are brass with stainless steel locking balls and ethylene propylene seals to withstand temperatures up to 400 F. 1/4 to 1 inch body sizes. 3/8 inch size couplers have a grip-ring sleeve.

Features:

- Accepts ISO 7241-1, Series B compliant nipples
- Poppet valves along with a metal to metal valve stop maintains valve alignment and prevents flow checking
- Brass couplers have double O-rings and stainless steel locking balls
- Standard end configuration is female pipe thread

Applications:

- Steam systems
- Cleaning equipment

Specifications

Body Size	1/4 to 1
Standard Seal Material	Ethylene Propylene
Temperature Range	up to +400°

Repair Kits - Steam Coupling

Body Size	Repair Kit Part No.	Used for Part No.
3/8	H68E-67K	H3-68
3/8	H69E-67K	H3-69

Couplers - Female Pipe Thread



H3-68 has grip-ring sleeve

Body Size	Part No. Brass	Thread Size	Length	Largest Diameter	Wrench Flats	Weight (lbs.)
1/4	BH2-60-STM	1/4-18 NPTF	2.26	1.14	0.81	0.30
3/8*	H3-68	3/8-18 NPTF	2.50	1.77	0.88	0.50
1/2	BH4-60-STM	1/2-14 NPTF	2.87	1.77	1.12	0.75
3/4	BH6-60-STM	3/4-14 NPTF	3.56	2.14	1.31	1.31
1	BH8-60-STM	1-11 1/2 NPTF	4.18	2.52	1.62	1.95

* See Photo for 3/8 inch size coupler configuration.

Nipple - Female Pipe Thread



Body Size	Part No. Brass	Thread Size	Overall Length	Exposed* Length	Largest Diameter	Wrench Flats	Weight (lbs.)
1/4	BH2-61-STM	1/4 - 18 NPTF	1.54	0.65	0.87	0.75	0.08
3/8	H3-69	3/8 - 18 NPTF	1.68	0.52	1.01	0.88	0.13
1/2	BH4-61-STM	1/2 - 14 NPTF	1.94	0.69	1.30	1.12	0.24
3/4	BH6-61-STM	3/4 - 14 NPTF	2.43	0.79	1.59	1.38	0.46
1	BH8-61-STM	1 - 11 1/2 NPTF	2.91	0.99	1.88	1.62	0.76

* This dimension represents the portion that is exposed when the nipple is inserted into the mating Parker Coupler.

Hydraulic Quick Couplings

General Purpose

6600 Series

ISO 7241 Series A

Manual sleeve, poppet valve



The 6600 Series are versatile for use in a wide range of hydraulic applications where fluid lines require connection and disconnection for equipment operation or maintenance

Features:

- Accepts ISO 7241-1, Series A compliant nipples
- Poppet valves and a metal perch to maintain valve alignment and prevent flow checking
- Coupler sleeve and nipple body are hardened to be damage resistant
- Standard end configurations include female pipe and straight thread ORB
- Protective zinc plating with clear trivalent chromate finish

Applications include:

- Snow plows
- Truck trailer connections
- Mobile applications
- Attachments

6600 Series Specifications:

Body Size	Rated Flow (gpm)	Rated Pressure (psi)	Temperature	Body Material	Sleeve Type	Seal Material
1/4	3	5000	-40° F to +250° F	Steel	Manual Connect	Nitrile
3/8	6	4000				
1/2	12	4000				
3/4	28	4000				
1	50	4000				

Performance:

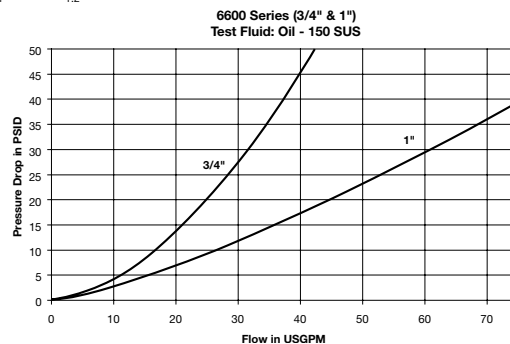
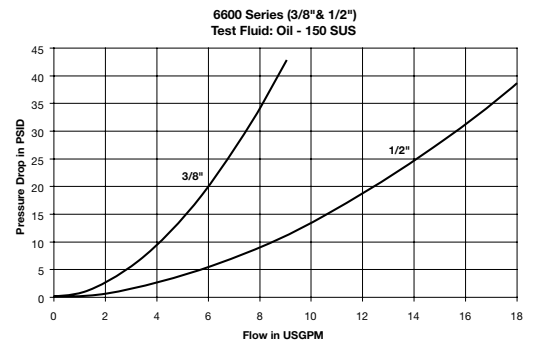
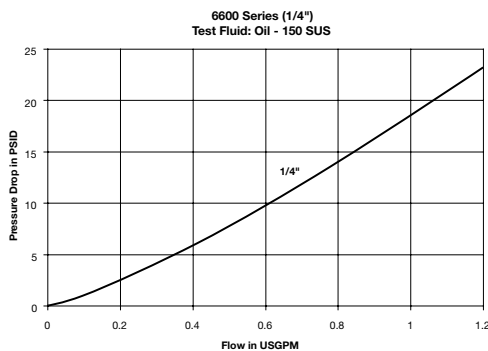



6600 Series Couplers



Body Size	Coupler Part Number	Port End	Valve Type	Length	Largest Diameter	Wrench Flats	Weight (lbs.)
1/4	6601-2-4	1/8-27 NPTF	Poppet	1.85	1.08	0.88	0.27
1/4	6601-4-4	1/4-18 NPTF	Poppet	1.85	1.08	0.88	0.26
3/8	6601-6-6	3/8-18 NPTF	Poppet	2.18	1.27	1.06	0.39
3/8	6608-6-6	9/16-18 ORB	Poppet	2.18	1.27	1.06	0.38
1/2	6601-8-10	1/2-14 NPTF	Poppet	2.75	1.52	1.25	0.67
1/2	6601-12-10	3/4-14 NPTF	Poppet	2.88	1.52	1.38	0.71
1/2	6608-8-10	3/4-16 ORB	Poppet	2.74	1.52	1.25	0.67
1/2	6608-10-10	7/8-14 ORB	Poppet	2.79	1.52	1.25	0.64
1/2	6608-12-10	1 1/16-12 ORB	Poppet	3.01	1.52	1.38	0.77
3/4	6601-12-12	3/4-14 NPTF	Poppet	3.36	1.90	1.62	1.31
3/4	6608-12-12	1 1/16-12 ORB	Poppet	3.35	1.90	1.62	1.31
1	6601-16-16	1-11 1/2 NPTF	Poppet	4.11	2.14	1.88	1.93
1	6608-16-16	1 5/16-12 ORB	Poppet	4.11	2.14	1.88	1.75

6600 Series Nipples



Body Size	Nipple Part Number	Port End	Valve Type	Length	Exposed Length*	Largest Diameter	Wrench Flats	Weight (lbs.)
1/4	6602-2-4	1/8-27 NPTF	Poppet	1.41	0.50	0.65	0.56	0.05
1/4	6602-4-4	1/4-18 NPTF	Poppet	1.41	0.58	0.87	0.75	0.07
3/8	6602-6-6	3/8-18 NPTF	Poppet	1.63	0.72	1.01	0.88	0.11
3/8	6610-6-6	9/16-18 ORB	Poppet	1.63	0.72	1.01	0.88	0.13
1/2	6602-8-10	1/2-14 NPTF	Poppet	2.08	0.78	1.23	1.06	0.21
1/2	6602-12-10	3/4-14 NPTF	Poppet	2.30	0.78	1.59	1.38	0.33
1/2	6610-8-10	3/4-16 ORB	Poppet	2.08	0.76	1.23	1.06	0.22
1/2	6610-10-10	7/8-14 ORB	Poppet	2.08	0.82	1.30	1.12	0.21
1/2	6610-12-10	1 1/16-12 ORB	Poppet	2.30	1.04	1.59	1.38	0.33
3/4	6602-12-12	3/4-14 NPTF	Poppet	2.55	1.18	1.59	1.38	0.49
3/4	6610-12-12	1 1/16-12 ORB	Poppet	2.55	1.18	1.59	1.38	0.47
1	6602-16-16	1-11 1/2 NPTF	Poppet	3.10	1.34	1.88	1.62	0.75
1	6610-16-16	1-5/16-12 ORB	Poppet	3.10	1.34	2.17	1.62	0.72

* This dimension represents the portion of the nipple that is exposed when the nipple and coupler are connected.

6600 Series Replacement Parts	1/4	3/8	1/2	3/4	1
O-Rings - Nitrile	50001-112-0010	50001-115-0010	50001-211-0010	50001-123-0010	50001-126-0010
Back-up Rings	4118006	4118005	50-140-4	4138001	4148002



6600 Series Dust Caps and Plugs



Body Size	Dust Plug (Coupler)	Color/Material	Dust Cap (Nipple)	Weight (lbs.)
1/4	H1-65M	Black Rubber	H1-66M	.02
3/8	TR-37	Black Rubber	TR-37	.04
1/2	5205-4M	Black Rubber	5209-4M	.04
3/4	6659-12M	Black Rubber	6657-12M	.06
1	6659-16M	Black Rubber	6657-16M	.08

Optional Materials and Features:

(add code to part number)

Code	Description	Part Number Example
suffix -SL	Sleeve-Lok (Couplers)	6601-6-6-SL
suffix W	Ethylene Propylene seal material (EPR)	6601-6-6W
suffix Y	Fluorocarbon seal material	6601-6-6Y
suffix Z	Neoprene seal material	6601-6-6Z

Contact QCD for availability and additional options.
To select proper seal materials, see Fluid Compatibility Chart or contact QCD.



Snap-tite H Series couplings have been proven by years of use on hydraulic applications.

H Series is best suited for general purpose fluid applications where either single or double shut-off valving is desired. A wide range of sizes, materials and end configurations are available.

PH version couplers and nipples are valved with a connect-under-pressure feature. These steel couplers and nipples allow connection with H Series valved couplers and nipples when there is a residual pressure on the PH coupler/nipple side. It is recommended that only one half of the connection (coupler or nipple) be PH version, not both.

Features:

- Sizes 1/4" - 4"
- Available in steel, brass, aluminum and 316 stainless steel
- Standard seal material is nitrile with other options available
- Optional sleeve lock helps to prevent accidental disconnection
- Double-shut-off version has low pressure drop
- Manually operated sleeve provides secure connection

Applications include:

- Industrial hydraulic lines
- Water and coolant lines
- Mobile equipment

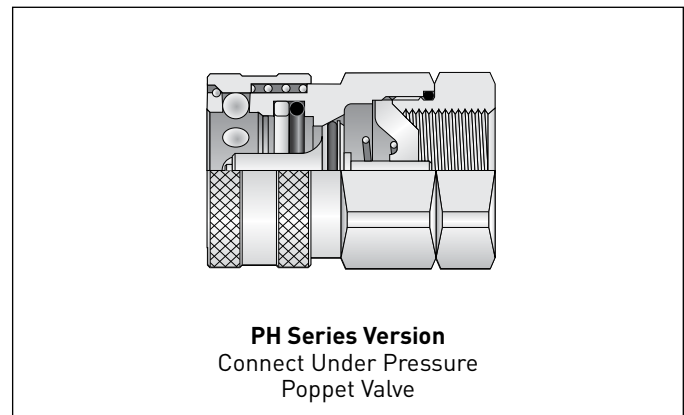
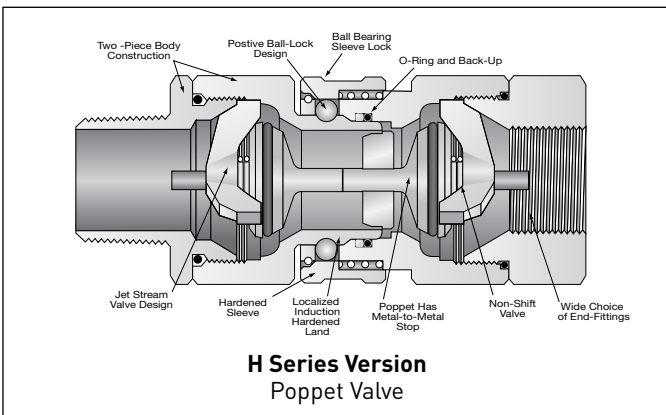

H & PH Series Working Pressures (psi)

Valved on both coupler and nipple (Double Shut-off)

Valved on one half and Unvalved/Plain on other half (Single Shut-off)

Body Size	1/4	3/8	1/2	3/4	1	1-1/4	1-1/2	2	2-1/2	3	4
Steel	6500	4500	4000	3500	2000	1750	1500	1500	1000	750	500
Aluminum	2250	2250	1750	1750	1500	375	375	300	300	200	150
Brass	2250	2250	2000	2000	1750	350	350	400	400	200	150
Stainless Steel	5000	4000	3750	2000	2000	1500	1500	500	400	400	300
Unvalved/Plain on both coupler and nipple (Straight Through)											
Steel	11000	11000	11000	9000	6000	5000	5000	4000	1000	750	500
Aluminum	4000	4000	4000	3500	3000	1000	1000	750	300	200	150
Brass	4000	4000	4000	3500	3000	1000	1000	750	300	200	150
Stainless Steel	10000	8000	8000	7000	4000	3000	3000	1000	400	400	300

NOTE: Pressure ratings were established under static pressure conditions. Therefore, pressure ratings for any given flow, pressure surge and/or vibration may vary from these ratings. Burst pressures listed were taken at the point at which failure rendered the quick disconnect inoperative. (Proof pressure equals 1-1/2 times the working pressure; burst pressure equals 2 times working pressure.)



Performance

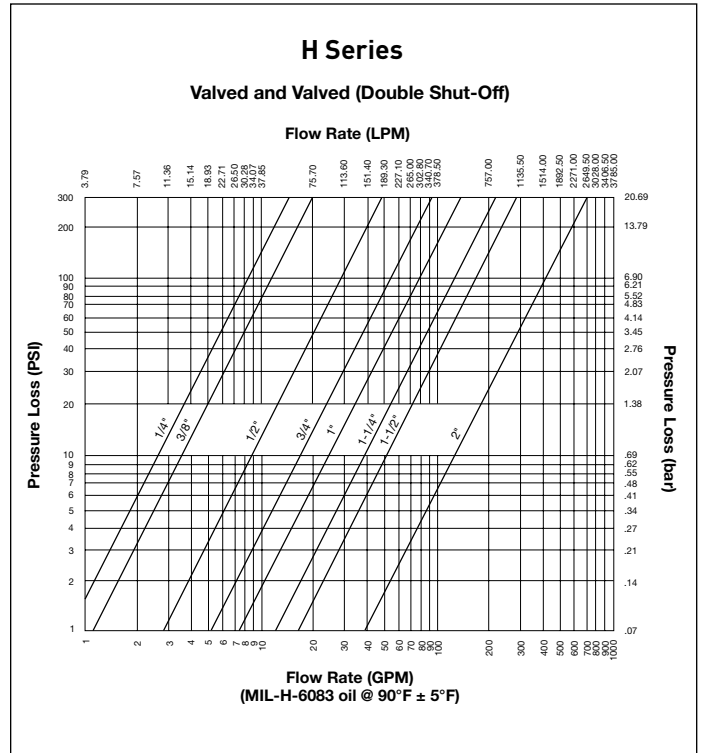
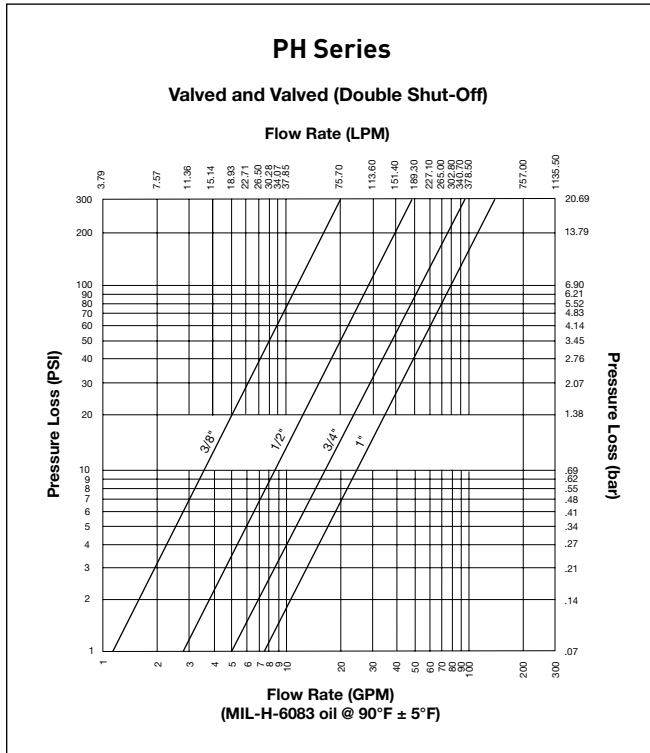

Repair Kits

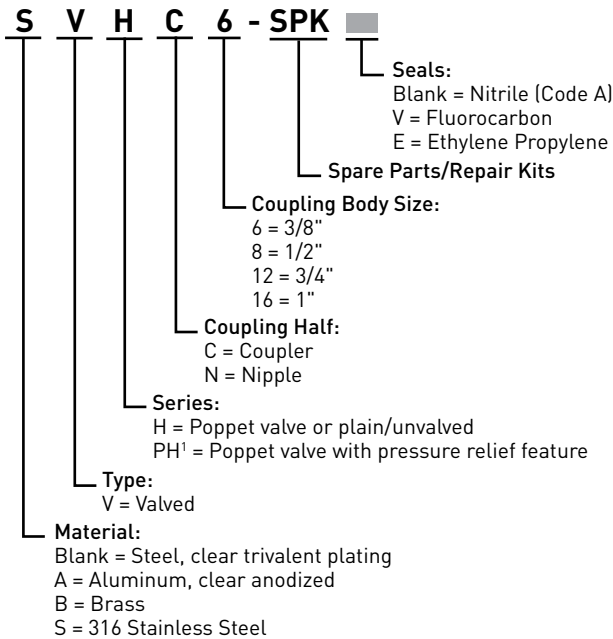

Repair kits include valve spring, valve stop and valve. O-ring installed on 3/8" to 1". 1/4" unit is non-field repairable.

Note: Not all configurations are standard product offering. Contact QCD for price and delivery.

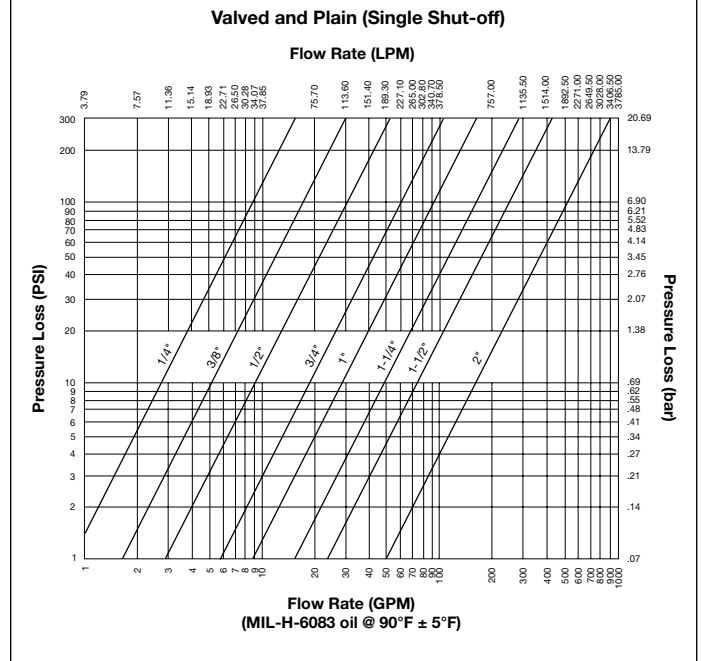

Hydraulic Quick Couplings

General Purpose

Snap-tite H & PH Series

Snap-tite Design

Manual Sleeve, Valved or Unvalved



B Hydraulics

Valve Options		
	H Series Hydraulic Coupler/Nipple	PH Series Hydraulic Coupler/Nipple
Valve Styles:	<ul style="list-style-type: none"> • Poppet Valve • Unvalved/Plain 	<ul style="list-style-type: none"> • Connect-Under-Pressure Poppet Valve
Connection Types:	<ul style="list-style-type: none"> • Double Shut-off • Single Shut-off • Straight Through/Unvalved 	<ul style="list-style-type: none"> • Double Shut-off (connects with valved H Series Coupler or Nipple)
Body Sizes:	1/8" - 4"	3/8" - 1"
Materials:	<ul style="list-style-type: none"> • Steel • 316 Stainless Steel • Aluminum • Brass 	<ul style="list-style-type: none"> • Steel

Replacement Coupler Interface Seals		
Body Size	Nitrile	Fluorocarbon
1/4	H4-56-9	H4-56-9V
3/8	H6-56-9	H6-56-9V
1/2	H8-56-9	H8-56-9V
3/4	H12-56-9	H12-56-9V
1	H16-56-9	H16-56-9V
1-1/4	H20-56-9	H20-56-9V

Replacement Valve Seals			
Body Size	Nitrile	Fluorocarbon	Ethylene Propylene
1-1/4	H20-55A	H20-55V	H20-55E
1-1/2	H24-55A	H24-55V	H24-55E
2	H32-55A	H32-55V	H32-55E

Ordering Guide

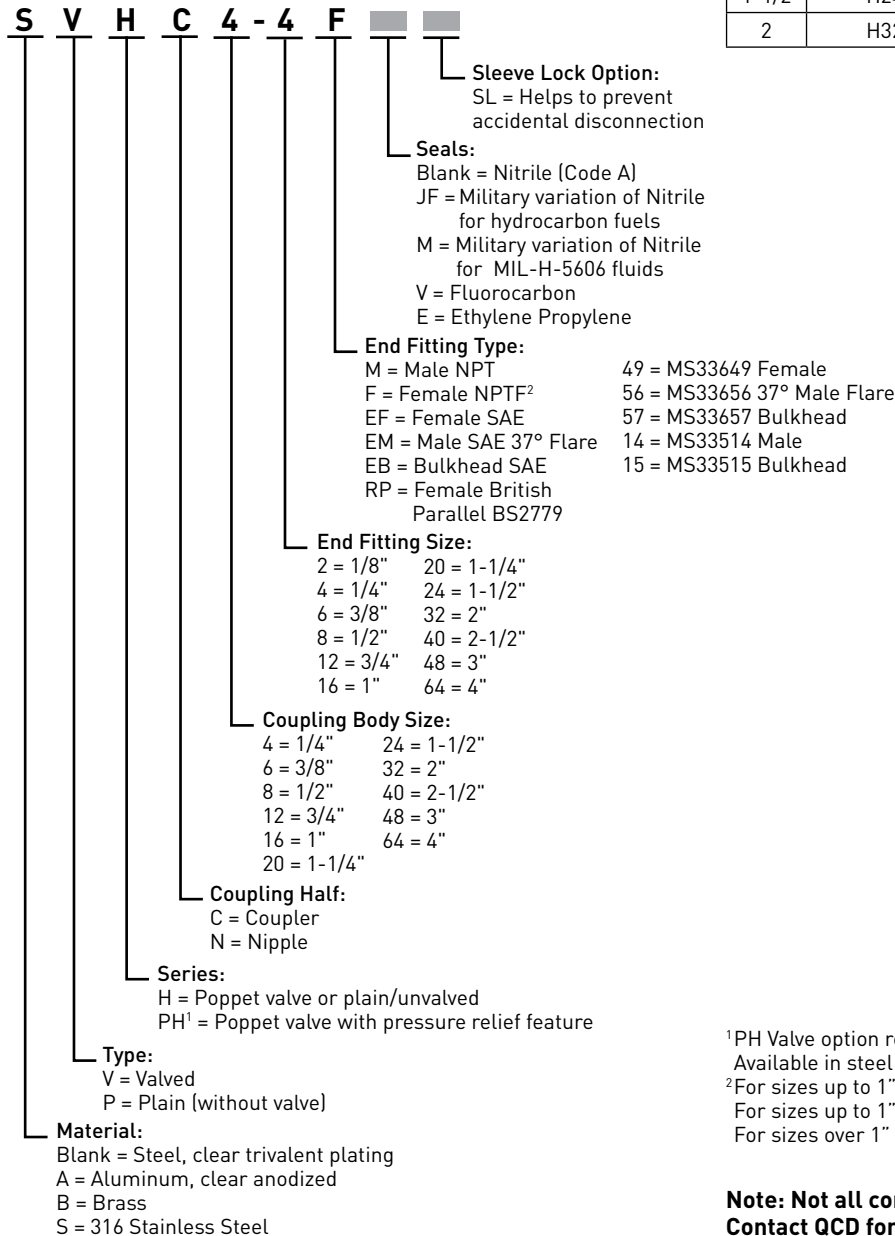

¹PH Valve option recommended on one side, not both. Available in steel only.
²For sizes up to 1" NPTF threads in steel. For sizes up to 1" NPSF threads in stainless steel. For sizes over 1" NPT threads.

Note: Not all configurations are standard product offering. Contact QCD for price and delivery.





H Series Couplers (Aluminum, Brass, Steel) - Female Thread



Body Size	Part Number Aluminum	Part Number Brass	Part Number Steel	Valved or Non-Valved (Plain)	Port End	Length (in)	Largest Diameter	Wrench Flats
1/4	-	-	VHC4-2F	Valved	1/8-27 NPTF	1.65	1.00	0.88
1/4	APHC4-4F	BPHC4-4F	PHC4-4F	Non-Valved	1/4-18 NPTF	1.34	1.02	0.88
1/4	AVHC4-4F	BVHC4-4F	VHC4-4F	Valved	1/4-18 NPTF	1.65	1.19	1.00
1/4	-	-	VHC4-4EF	Valved	7/16-20 UNF	1.80	1.02	0.88
3/8	APHC6-6F	BPHC6-6F	PHC6-6F	Non-Valved	3/8-18 NPTF	1.50	1.19	1.00
3/8	AVHC6-6F	BVHC6-6F	VHC6-6F	Valved	3/8-18 NPTF	1.90	1.19	1.00
3/8	-	-	VHC6-6EF	Valved	9/16-18 UNF	2.20	1.19	1.00
1/2	-	BPHC8-8F	PHC8-8F	Non-Valved	1/2-18 NPTF	1.62	1.39	1.19
1/2	AVHC8-8F	BVHC8-8F	VHC8-8F	Valved	1/2-18 NPTF	2.09	1.39	1.19
1/2	-	-	VHC8-8EF	Valved	3/4-16 UNF	2.19	1.39	1.19
3/4	-	BPHC12-12F	PHC12-12F	Non-Valved	3/4-18 NPTF	1.91	1.73	1.50
3/4	-	BVHC12-12F	VHC12-12F	Valved	3/4-18 NPTF	2.42	1.73	1.50
3/4	-	-	VHC12-12EFV	Valved	1-1/16 - 12 UNF	2.92	1.73	1.50
1	-	BPHC16-16F	PHC16-16F	Non-Valved	1 - 11-1/2 NPTF	2.07	2.17	1.88
1	-	BVHC16-16F	VHC16-16F	Valved	1 - 11-1/2 NPTF	2.67	2.17	1.88
1	-	-	VHC16-16EF	Valved	1-5/16 - 12 UNF	2.94	2.17	1.88
1-1/4	-	BPHC20-20F	PHC20-20F	Non-Valved	1-1/4 - 11-1/2 NPT	2.28	2.31	2.00
1-1/4	-	BVHC20-20F	VHC20-20F	Valved	1-1/4 - 11-1/2 NPT	3.54	2.31	2.00
1-1/2	-	BPHC24-24F	PHC24-24F	Non-Valved	1-1/2 - 11-1/2 NPT	2.57	2.89	2.50
1-1/2	-	BVHC24-24F	VHC24-24F	Valved	1-1/2 - 11-1/2 NPT	3.27	3.18	2.75
2	-	BPHC32-32F	PHC32-32F	Non-Valved	2 - 11-1/2 NPT	2.48	3.75	3.25
2	-	BVHC32-32F	VHC32-32F	Valved	2 - 11-1/2 NPT	3.92	4.33	3.75



H Series Couplers (316 Stainless Steel) - Female Thread



Body Size	Part Number Stainless Steel	Valved or Non-Valved (Plain)	Port End	Length (in)	Largest Diameter	Wrench Flats
1/4	SVHC4-2F	Valved	1/8-27 NPSF*	1.65	1.00	0.88
1/4	SPHC4-4F	Non-Valved	1/4-18 NPSF*	1.34	1.02	0.88
1/4	SVHC4-4F	Valved	1/4-18 NPSF*	1.65	1.19	1.00
3/8	SPHC6-6F	Non-Valved	3/8-18 NPSF*	1.50	1.19	1.00
3/8	SVHC6-6F	Valved	3/8-18 NPSF*	1.90	1.19	1.00
1/2	SPHC8-8F	Non-Valved	1/2-18 NPSF*	1.62	1.39	1.19
1/2	SVHC8-8F	Valved	1/2-18 NPSF*	2.09	1.39	2.09
3/4	SPHC12-12F	Non-Valved	3/4-18 NPSF*	1.91	1.73	1.50
3/4	SVHC12-12F	Valved	3/4-18 NPSF*	2.42	1.73	1.50
1	SPHC16-16F	Non-Valved	1 - 11-1/2 NPSF*	2.07	2.17	1.88
1	SVHC16-16F	Valved	1 - 11-1/2 NPSF*	2.67	2.17	1.88
1-1/4	SPHC20-20F	Non-Valved	1-1/4 - 11-1/2 NPT	2.28	2.31	2.00
1-1/4	SVHC20-20F	Valved	1-1/4 - 11-1/2 NPT	3.54	2.31	2.00
1-1/2	SPHC24-24F	Non-Valved	1-1/4 - 11-1/2 NPT	2.57	2.89	2.50
1-1/2	SVHC24-24F	Valved	1-1/2 - 11-1/2 NPT	3.27	3.18	2.75
2	SPHC32-32F	Non-Valved	2 - 11-1/2 NPT	2.48	3.75	3.25
2	SVHC32-32F	Valved	2 - 11-1/2 NPT	3.92	4.33	3.75

*NPSF thread may be substituted with equivalent NPT thread

H Series Couplers (Aluminum, Brass, Steel) - Male Thread



Body Size	Part Number Aluminum	Part Number Brass	Part Number Steel	Valved or Non-Valved (Plain)	Port End	Length (in)	Largest Diameter	Wrench Flats
1/4	-	-	VHC4-2M	Valved	1/8-27 NPT	1.90	1.00	0.88
1/4	AVHC4-4M	BVHC4-4M	VHC4-4M	Valved	1/4-18 NPT	2.09	1.02	0.88
3/8	AVHC6-6M	-	VHC6-6M	Valved	3/8-18 NPT	2.19	1.19	1.00
3/8	-	BVHC6-6M	-	Valved	3/8-18 NPT	1.90	1.19	1.00
1/2	-	BVHC8-8M	-	Valved	1/2-18 NPT	2.57	1.39	1.19
1/2	-	-	VHC8-8M	Valved	1/2-18 NPT	2.46	1.39	1.19
3/4	-	BVHC12-12M	VHC12-12M	Valved	3/4-18 NPT	2.88	1.73	1.50
1	-	BVHC16-16M	VHC16-16M	Valved	1-11-1/2 NPT	3.21	2.17	1.88
2	-	-	VHC32-32M	Valved	2-11-1/2 NPT	4.54	4.33	3.75



H Series Couplers (316 Stainless Steel) - Male Thread



Body Size	Part Number	Valved or Non-Valved (Plain)	Port End	Length (in)	Largest Diameter	Wrench Flats
1/4	SVHC4-4M	Valved	1/4-18 NPT	2.09	1.02	0.88
3/8	SVHC6-6M	Valved	3/8-18 NPT	2.19	1.19	1.00
1/2	SVHC8-8M	Valved	1/2-18 NPT	2.57	1.39	1.19
3/4	SVHC12-12M	Valved	3/4-18 NPT	2.88	1.73	1.50
1	SVHC16-16M	Valved	1 - 11-1/2 NPT	3.21	2.17	1.88

H Series Couplers (Steel) - Male SAE 37 Degree Flare



Body Size	Part Number	Valved or Non-Valved (Plain)	Port End	Length (in)	Largest Diameter	Wrench Flats
1/4	VHC4-4EM	Valved	7/16-20 UNF	2.80	1.02	0.88
3/8	VHC6-6EM	Valved	9/16-18 UNF	2.24	1.19	1.00
1/2	VHC8-8EM	Valved	3/4-16 UNF	2.46	1.39	1.19
3/4	VHC12-12EM	Valved	1-1/6 - 12 UNF	3.05	1.73	1.50

PH Series Connect-Under-Pressure Couplers (Steel) - Female Thread



Body Size	Part Number	Valved or Non-Valved (Plain)	Port End	Length (in)	Largest Diameter	Wrench Flats
3/8	VPHC6-6F	Valved	3/8-18 NPTF	1.90	1.19	1.00
1/2	VPHC8-8F	Valved	1/2-14 NPTF	2.09	1.39	1.19
3/4	VPHC12-12EF	Valved	1-1/16 - 12 UNF	2.92	1.73	1.50
3/4	VPHC12-12F	Valved	3/4-14 NPTF	2.42	1.73	1.50



H Series Nipples (Aluminum, Brass, Steel) - Female Thread



Body Size	Part Number Aluminum	Part Number Brass	Part Number Steel	Valved or Non-Valved (Plain)	Port End	Length (in)	Largest Diameter	Wrench Flats
1/4	-	BPHN4-2F	PHN4-2F	Non-Valved	1/8-27 NPTF	1.11	0.62	0.56
1/4	-	-	VHN4-2F	Valved	1/8-27 NPTF	1.59	1.00	0.88
1/4	APHN4-4F	BPHN4-4F	-	Non-Valved	1/4-18 NPTF	1.32	0.73	0.88
1/4	AVHN4-4F	BVHN4-4F	-	Valved	1/4-18 NPTF	1.59	1.02	0.88
1/4	-	-	PHN4-4F	Valved	1/4-18 NPTF	1.32	0.73	0.63
1/4	-	-	VHN4-4F	Valved	1/4-18 NPTF	1.65	1.19	1.00
3/8	APHN6-6F	BPHN6-6	-	Non-Valved	3/8-18 NPTF	1.52	0.94	1.00
3/8	-	-	PHN6-6F	Non-Valved	3/8-18 NPTF	1.52	0.94	0.81
3/8	AVHN6-6F	BVHN6-6F	VHN6-6F	Valved	3/8-18 NPTF	1.84	1.19	1.00
1/2	AVHN8-8F	-	-	Valved	1/2-18 NPTF	1.98	1.19	1.00
1/2	-	BPHN8-8F	PHN8-8F	Non-Valved	1/2-18 NPTF	1.72	1.15	1.00
1/2	-	BVHN8-8F	VHN8-8F	Valved	1/2-18 NPTF	1.98	1.39	1.19
1/2	-	-	VHN8-8EF	Valved	3/4-16 UNF	2.08	1.39	1.19
3/4	-	BPHN12-12F	PHN12-12F	Non-Valved	3/4-18 NPTF	1.92	1.37	1.19
3/4	-	BVHN12-12F	VHN12-12F	Valved	3/4-18 NPTF	2.29	1.73	1.50
3/4	-	-	VHN12-12EF	Valved	1-1/16 - 12 UNF	2.79	1.73	1.50
1	-	BPHN16-16F	PHN16-16F	Non-Valved	1 - 11-1/2 NPTF	2.10	1.73	1.50
1	-	BVHN16-16F	VHN16-16F	Valved	1 - 11-1/2 NPTF	2.55	2.17	1.88
1	-	-	VHN16-16EF	Valved	1-5/16 - 12 UNF	2.82	2.17	1.88
1-1/4	-	BPHN20-20F	PHN20-20F	Non-Valved	1-1/4 - 11-1/2 NPTF	2.22	2.17	1.88
1-1/4	-	BVHN20-20F	VHN20-20F	Valved	1-1/4 - 11-1/2 NPTF	3.41	2.31	2.00
1-1/2	-	BPHN24-24F	PHN24-24F	Non-Valved	1-1/2 - 11-1/2 NPTF	2.44	2.46	2.13
1-1/2	-	BVHN24-24F	VHN24-24F	Valved	1-1/2 - 11-1/2 NPTF	3.11	3.18	2.75
2	-	BPHN32-32F	PHN32-32F	Non-Valved	2 - 11-1/2 NPTF	2.60	3.18	2.75
2	-	BVHN32-32F	VHN32-32F	Valved	2 - 11-1/2 NPTF	3.72	4.33	3.75



H Series Nipples (316 Stainless Steel) - Female Thread



Body Size	Part Number	Valved or Non-Valved (Plain)	Port End	Length (in)	Largest Diameter	Wrench Flats
1/4	SPHN4-2F	Non-Valved	1/8-27 NPSF*	1.11	0.62	0.56
1/4	SVHN4-2F	Valved	1/8-27 NPSF*	1.59	1.00	0.56
1/4	SPHN4-4F	Non-Valved	1/4-18 NPSF*	1.32	0.73	0.63
1/4	SVHN4-4F	Valved	1/4-18 NPSF*	1.59	1.02	0.88
3/8	SPHN6-6F	Non-Valved	3/8-18 NPSF*	1.52	0.94	0.81
3/8	SVHN6-6F	Valved	3/8-18 NPSF*	1.84	1.19	1.00
1/2	SPHN8-8F	Non-Valved	1/2-18 NPSF*	1.72	1.15	2.00
1/2	SVHN8-8F	Valved	1/2-18 NPSF*	1.98	1.39	1.19
3/4	SPHN12-12F	Non-Valved	3/4-18 NPSF*	1.92	1.37	1.19
3/4	SVHN12-12F	Valved	3/4-18 NPSF*	2.29	1.73	1.50
1	SPHN16-16F	Non-Valved	1 - 11-1/2 NPSF*	2.10	1.73	1.50
1	SVHN16-16F	Valved	1 - 11-1/2 NPSF*	2.55	2.17	1.88
1-1/4	SPHN20-20F	Non-Valved	1-1/4 - 11-1/2 NPTF	2.22	2.17	1.88
1-1/4	SVHN20-20F	Valved	1-1/4 - 11-1/2 NPTF	3.41	2.31	1.88
1-1/2	SPHN24-24F	Non-Valved	1-1/2 - 11-1/2 NPTF	2.44	2.46	2.13
1-1/2	SVHN24-24F	Valved	1-1/2 - 11-1/2 NPTF	3.11	3.18	3.75
2	SPHN32-32F	Non-Valved	2 - 11-1/2 NPTF	2.60	3.18	2.75
2	SVHN32-32F	Valved	2 - 11-1/2 NPTF	3.72	4.33	3.75

*NPSF thread may be substituted with equivalent NPT thread



H Series Nipples (Aluminum, Brass, Steel) - Male Thread



Body Size	Part Number Aluminum	Part Number Brass	Part Number Steel	Valved or Non-Valved (Plain)	Port End	Length (in)	Largest Diameter	Wrench Flats
1/4	-	BPHN4-2M	-	Non-Valved	1/8-27 NPT	1.22	0.64	0.56
1/4	-	-	PHN4-2M	Non-Valved	1/8-27 NPT	1.11	0.62	0.56
1/4	-	-	VHN4-2M	Valved	1/8-27 NPT	1.85	1.00	0.88
1/4	APHN4-4M	BPHN4-4M	PHN4-4M	Non-Valved	1/4-18 NPT	0.78	0.65	0.56
1/4	AVHN4-4M	BVHN4-4M	VHN4-4M	Valved	1/4-18 NPT	2.03	1.02	0.88
3/8	-	BPHN6-6M	PHN6-6M	Non-Valved	3/8-18 NPT	0.98	0.80	0.69
3/8	AVHN6-6M	BVHN6-6M	VHN6-6M	Valved	3/8-18 NPT	2.13	1.19	1.00
1/2	-	BPHN8-8M	PHN8-8M	Non-Valved	1/2-18 NPT	1.01	1.02	0.88
1/2	-	BVHN8-8M	VHN8-8M	Valved	1/2-18 NPT	2.46	1.39	1.19
3/4	-	BPHN12-12M	PHN12-12M	Non-Valved	3/4-18 NPT	1.14	1.22	1.06
3/4	-	BVHN12-12M	VHN12-12M	Valved	3/4-18 NPT	2.75	1.73	1.50
1	-	BPHN16-16M	-	Non-Valved	1 - 11-1/2 NPT	1.16	1.59	1.38
1	-	-	PHN16-16M	Non-Valved	1-11-1/2 NPT	1.16	1.73	1.88
1	-	BVHN16-16M	VHN16-16M	Valved	1 - 11-1/2 NPT	3.09	2.17	1.88
1-1/4	-	-	VHN20-20M	Valved	1-1/4 - 11-1/2 NPT	3.46	2.31	2.00
2	-	-	PHN32-32M	Non-Valved	2 - 11-1/2 NPT	2.03	2.89	2.50

H Series Nipples (316 Stainless Steel) - Male Thread



Body Size	Part Number	Valved or Non-Valved (Plain)	Port End	Length (in)	Largest Diameter	Wrench Flats
1/4	SPHN4-2M	Non-Valved	1/8-27 NPT	1.22	0.64	0.56
1/4	SPHN4-4M	Non-Valved	1/4-18 NPT	0.78	0.65	0.56
1/4	SVHN4-4M	Valved	1/4-18 NPT	2.03	1.02	0.88
3/8	SPHN6-6M	Non-Valved	3/8-18 NPT	0.98	0.80	0.69
3/8	SVHN6-6M	Valved	3/8-18 NPT	2.13	1.19	1.00
1/2	SPHN8-8M	Non-Valved	1/2-18 NPT	1.01	1.02	0.88
1/2	SVHN8-8M	Valved	1/2-18 NPT	2.46	1.39	1.19
3/4	SVHN12-12M	Valved	3/4-18 NPT	2.75	1.73	1.50
1	SVHN16-16M	Valved	1 - 11-1/2 NPT	3.09	2.17	1.80
1-1/4	SVHN20-20M	Valved	1-1/4 - 11-1/2 NPT	3.46	2.31	2.00



H Series Nipples (Steel) - Male SAE 37 Degree Flare



Body Size	Part Number	Valved or Non-Valved (Plain)	Port End	Length (in)	Largest Diameter	Wrench Flats
1/4	VHN4-4EM	Valved	7/16-20 UNF	2.02	1.02	0.88
3/8	VHN6-6EM	Valved	9/16-18 UNF	2.24	1.19	1.00
1/2	VHN8-8EM	Valved	3/4-16 UNF	2.35	1.39	1.19
3/4	VHN12-12EM	Valved	1-1/6 - 12 UNF	2.92	1.73	1.50

PH Series Connect-Under-Pressure Nipples (Steel)



Body Size	Part Number	Valved or Non-Valved (Plain)	Port End	Length (in)	Largest Diameter	Wrench Flats
1/2	VPHN8-8F	Valved	1/2-14 NPTF (Female)	1.98	1.39	1.19
1/2	VPHN8-8EM	Valved	3/4-16 UNF (Male)	2.35	1.39	1.19

H Series Dust Plugs and Caps



Body Size	Coupler Dust Plug Plastic	Coupler Dust Plug Aluminum	Nipple Dust Cap Plastic	Nipple Dust Cap Aluminum	Nipple Pressure Cap
1/4	PDP-4	AMPH-4	PDC-4	ADCH-4	MCH-4
3/8	PDP-6	AMPH-6	PDC-6	ADCH-6	MCH-6
1/2	PDP-8	AMPH-8	PDC-8	ADCH-8	MCH-8
3/4	PDP-12	AMPH-12	PDC-12	ADCH-12	MCH-12
1	PDP-16	AMPH-16	PDC-16	ADCH-16	MCH-16
1-1/4	-	AMPH-20	-	ADCH-20	MCH-20
1-1/2	-	AMPH-24	-	ADCH-24	MCH-24
2	-	AMPH-32	-	ADCH-32	MCH-32
2-1/2	-	AMPH-40	-	ADCH-40	MCH-40
3	-	AMPH-48	-	ADCH-48	MCH-48



EA Series couplings are designed specifically for vacuum and medium pressure service, providing a dependable means for speeding fluid line changeover in autoclave applications.

Features:

- Vacuum capability
- Available in a variety of materials
- Wide range of sizes
- Nitrile is standard seal material, other options available

Applications include:

- Aircraft fabrication
- Plastic molding
- Horizontal boring and dewatering



B Hydraulics

EA Series Specifications				
Body Size	Force to Connect (Valved and Valved)		Spillage on Disconnect (Valved and Valved)	
	Internal Pressure (psi)	Force to Connect (lbs)	With 10 psi Internal Pressure (cc or ml)	With 50 psi Pressure (cc or ml)
1/4	200	50	1.2	1.5
3/8	200	60	1.4	2.5
1/2	200	95	4.2	4.6
3/4	100	95	10.5	11.6

EA Series Pressure Ratings						
Body Size	Steel		316 Stainless Steel		Brass	
	Maximum Working (psi)	Minimum Burst (psi)	Maximum Working (psi)	Minimum Burst (psi)	Maximum Working (psi)	Minimum Burst (psi)
1/4	3000	6000	3000	6000	1500	3000
3/8	3000	6000	3000	6000	1500	3000
1/2	3000	6000	3000	6000	1500	3000
3/4	2000	4000	2000	4000	1500	3000

Pressure ratings were established under static pressure conditions. Therefore, pressure ratings for any given flow, pressure surge and/or vibration may vary from those ratings.

Vacuum Capability at Standard Barometric Conditions								
	1/4		3/8		1/2		3/4	
	in.hg	atm	in.hg	atm	in.hg	atm	in.hg	atm
Connected	29.7	.99	29.7	.99	29.7	.99	29.7	.99
Coupler or Nipple Alone (disconnected)	29.7	.99	29.7	.99	29.7	.99	29.7	.99



Performance

EA Series Valved & Valved (Double Shut-off)

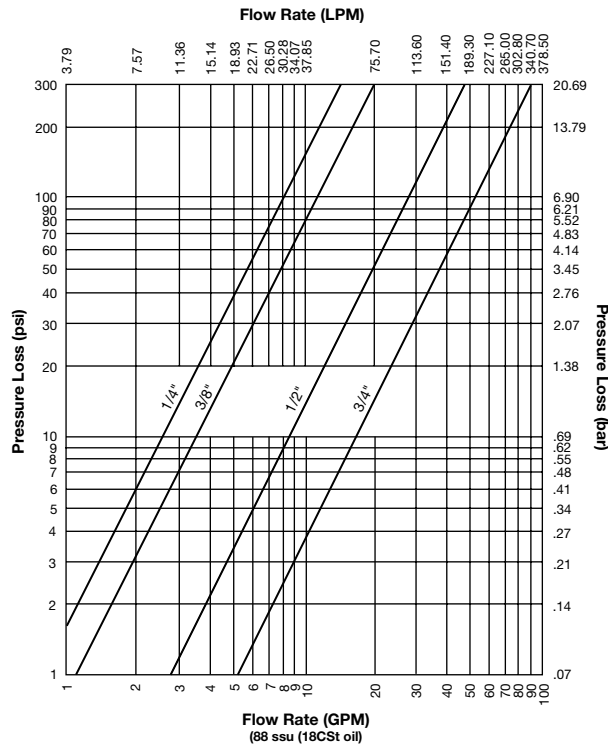

EA Series Valved & Plain (Single Shut-off)

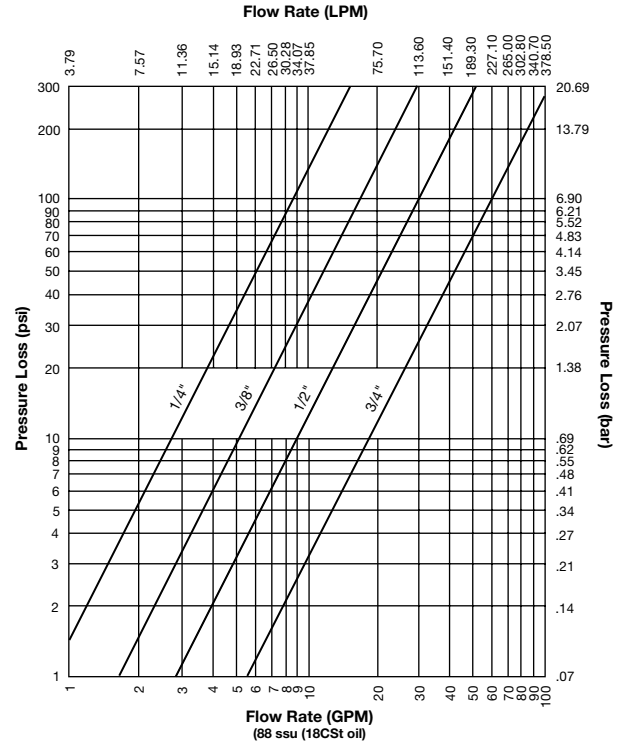

EA Series Repair Kits and Replacement Parts			
Body Size	Part Number	Description	Seal Material
1/2	VEAC8-SPK	Coupler Valve Repair Kit	Nitrile
1/2	VEAN8-SPK	Nipple Valve Repair Kit	Nitrile
1/4	EA4-58AS	Coupler Interface Seal	Aflas
1/2	EA8-58V	Coupler Interface Seal	Fluorocarbon
3/4	EA12-55A	Valve Seal	Nitrile
3/4	EA12-58A	Coupler Interface Seal	Nitrile

Repair Kits

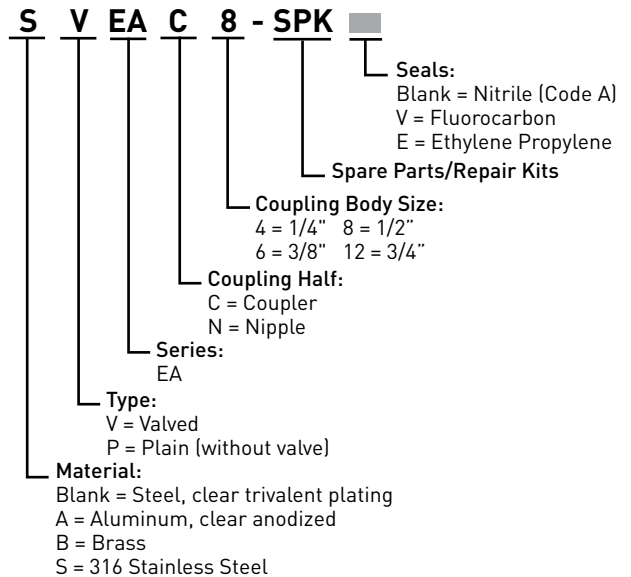

Optional Seal Materials for Couplers and Valved Nipples

(add code to part number)

Code	Description	Part Number Example
suffix V	Fluorocarbon seal material	VEAN4-4FV
suffix E	Ethylene Propylene seal material (EPR)	VEAC6-6ME
suffix AS	Aflas seal material	VEAC6-6FAS

Contact QCD for availability and additional options.
To select proper seal materials, see Fluid Compatibility Chart or contact QCD.



EA Series Couplers (Brass, Steel, 316 Stainless Steel) - Female Thread



Body Size	Part Number Brass	Part Number Steel	Port End	Part Number 316 Stainless Steel	Port End*	Valved or Non-Valved (Plain)	Length (in)	Largest Diameter	Wrench Flats
1/4	BPEAC4-4F	PEAC4-4F	1/4-18 NPTF	SPEAC4-4F	1/4-18 NPSF	Non-Valved	1.33	1.13	0.88
1/4	BVEAC4-4F	VEAC4-4F	1/4-18 NPTF	SVEAC4-4F	1/4-18 NPSF	Valved	1.61	1.13	0.88
3/8	BPEAC6-6F	PEAC6-6F	3/8-18 NPTF	-	-	Non-Valved	1.58	1.31	1.00
3/8	BVEAC6-6F	VEAC6-6F	3/8-18 NPTF	-	-	Valved	1.86	1.31	1.00
1/2	BPEAC8-8F	PEAC8-8F	1/2-14 NPTF	-	-	Non-Valved	1.70	1.44	1.19
1/2	BVEAC8-8F	VEAC8-8F	1/2-14 NPTF	SVEAN8-8F	1/2-14NPSF	Valved	2.09	1.44	1.19
3/4	BPEAC12-12F	-	3/4-14 NPTF	SPEAN12-12F	3/4-14 NPSF	Non-Valved	2.41	1.88	1.50
3/4	BVEAC12-12F	VEAC12-12F	3/4-14 NPTF	SVEAN12-12F	3/4-14 NPSF	Valved	1.91	1.88	1.50

EA Series Couplers (Brass, Steel, 316 Stainless Steel) - Male Thread



Body Size	Part Number Brass	Part Number Steel	Port End	Part Number 316 Stainless Steel	Port End*	Valved or Non-Valved (Plain)	Length (in)	Largest Diameter	Wrench Flats
1/4	-	PEAC4-4M	1/4-18 NPTF	SPEAC4-4M	1/4-18 NPSF	Non-Valved	1.48	1.13	0.88
1/4	-	VEAC4-4M	1/4-18 NPTF	SVEAC4-2M	1/4-18 NPSF	Valved	2.05	1.13	0.88
3/8	BVEAC6-6M	VEAC6-6M	3/8-18 NPTF	-	-	Valved	2.15	1.31	1.00
1/2	BVEAC8-8M	VEAC8-8M	1/2-14 NPTF	SVEAC8-8M	1/2-14 NPSF	Valved	2.46	1.44	1.19
3/4	BVEAC12-12M	VEAC12-12M	3/4-14 NPTF	-	-	Valved	2.87	1.88	1.50

*May be substituted with NPT threads

Contact QCD for additional sizes, materials and end configurations.



EA Series Nipples (Brass, Steel, 316 Stainless Steel) - Female Thread



Body Size	Part Number Brass	Part Number Steel	Port End	Part Number 316 Stainless Steel	Port End*	Valved or Non-Valved (Plain)	Length (in)	Largest Diameter	Wrench Flats
1/4	-	-	-	SVEAN4-2F	1/8-27 NPSF	Valved	1.61	1.00	0.88
1/4	BPEAN4-4F	PEAN4-4F	1/4-18 NPTF	SPEAN4-4F	1/4-18 NPSF	Non-Valved	1.33	0.73	0.62
1/4	-	VEAN4-4F	1/4-18 NPTF	SVEAN4-4F	1/4-18 NPSF	Valved	1.61	1.00	0.88
3/8	BPEAN6-6F	PEAN6-6F	3/8-18 NPTF	-	-	Non-Valved	1.58	0.94	0.81
3/8	BVEAN6-6F	VEAN6-6F	3/8-18 NPTF	-	-	Valved	1.86	1.15	1.00
1/2	BPEAN8-8F	PEAN8-8F	1/2-14 NPTF	-	-	Non-Valved	1.70	1.15	1.00
1/2	BVEAN8-8F	VEAN8-8F	1/2-14 NPTF	SVEAN8-8F	1/2-14 NPSF	Valved	2.09	1.31	1.19
3/4	BPEAN12-12F	-	3/4-14 NPTF	SPEAN12-12F	3/4-14 NPSF	Non-Valved	2.05	1.37	1.19
3/4	BVEAN12-12F	VEAN12-12F	3/4-14 NPTF	SVEAN12-12F	3/4-14 NPSF	Valved	2.29	1.73	1.50

EA Series Nipples (Brass, Steel, 316 Stainless Steel) - Male Thread



Body Size	Part Number Brass	Part Number Steel	Port End	Part Number 316 Stainless Steel	Port End*	Valved or Non-Valved (Plain)	Length (in)	Largest Diameter	Wrench Flats
1/4	-	PEAN4-4M	1/4-18 NPTF	SPEAN4-4M	1/4-18 NPSF	Non-Valved	1.43	0.65	0.56
1/4	-	VEAN4-4M	1/4-18 NPTF	SVEAN4-4M	1/4-18 NPSF	Valved	2.21	1.02	0.88
3/8	BVEAN6-6M	VEAN6-6M	3/8-18 NPTF	-	-	Valved	2.15	1.15	1.00
1/2	BVEAN8-8M	VEAN8-8M	1/2-14 NPTF	SVEAN8-8M	1/2-14 NPSF	Valved	2.46	1.31	1.19
3/4	BVEAN12-12M	VEAN12-12M	3/4-14 NPTF	-	-	Valved	2.75	1.65	1.50

*May be substituted with NPT threads
 Contact QCD for additional sizes, materials and end configurations.

EA Series Dust Plugs and Caps



Body Size	Coupler Dust Plug Plastic	Coupler Dust Plug Aluminum	Nipple Dust Cap Plastic	Nipple Dust Cap Aluminum	Nipple Pressure Cap
1/4	PDP-4	AMPE-4	PDC-4	ADCE-4	MCE-4
3/8	PDP-6	AMPE-6	PDC-6	ADCE-6	MCE-6
1/2	PDP-8	AMPE-8	PDC-8	ADCE-8	MCE-8
3/4	PDP-12	AMPE-12	PDC-12	ADCE-12	MCE-12



SM Series double shut-off couplings are versatile for use across a spectrum of hydraulic applications where fluid lines require connection and disconnection. Couplers and nipples are steel with nitrile seals and are available in 1/4 through 3/4 inch sizes.

Features:

- Rated pressures up to 6000 psi
- Poppet valves have captive seals to minimize seal washout
- Steel material with standard nitrile seals
- Standard end configurations include female pipe, straight thread ORB, and British pipe
- Alternative seal materials available

Applications:

- Industrial hydraulic lines
- Mobile equipment



Specifications

Body Size	1/4	1/2	3/4
Rated Pressure (PSI)	6,000	6,000	4,500
Rated Flow (GPM)	3	12	28
Temperature Range (Nitrile Seals)	-40° to +250°F		

Performance

SM Series (1/4")
Test Fluid: Oil - 200 SUS

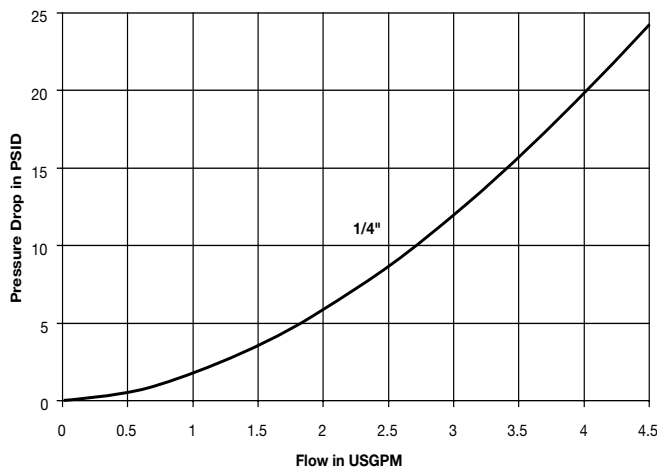

SM Series (1/2" & 3/4")
Test Fluid: Oil - 200 SUS

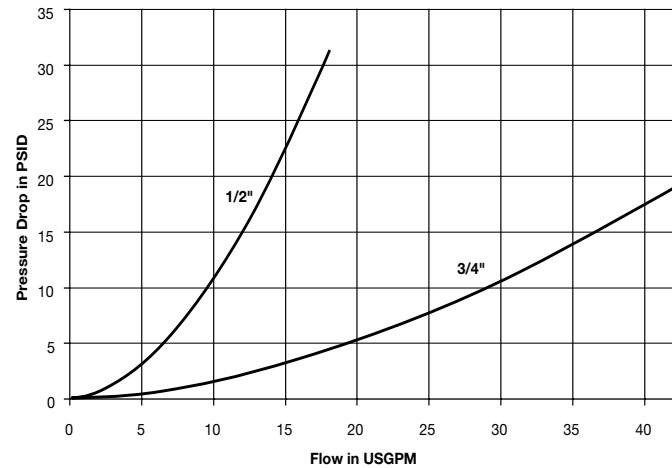

Optional Materials and Features:

(add code to part number)

Code	Description	Part Number Example
suffix -SL	Sleeve-Lok (Couplers)	SM-501-8FP-SL
suffix -E5	Ethylene Propylene seal material (EPR)	SM-501-8FP-E5
suffix -E4	Fluorocarbon seal material	SM-501-8FP-E4
suffix -E12	Neoprene seal material	SM-501-8FP-E12

Contact QCD for availability and additional options.
To select proper seal materials, see Fluid Compatibility Chart or contact QCD.



Couplers - Female Thread



Body Size	Part Number Steel	Thread Size	Length	Largest Diameter	Wrench Flats	Weight (lbs.)
1/4	SM-251-4FP	1/4-18 NPTF	2.09	1.06	0.75	0.24
1/4	SM-251-4FB	G1/4 BSPP	2.24	1.06	0.75	0.26
1/4	SM-251-6FP	3/8-18 NPTF	2.24	1.06	0.94	0.28
1/4	SM-251-6FB	G3/8 BSPP	2.24	1.06	0.94	0.26
1/4	SM-251-6FO	9/16-18 ORB	2.24	1.06	0.75	0.25
1/2	SM-501-8FP	1/2-14 NPTF	3.00	1.56	1.25	0.70
1/2	SM-501-8FB	G1/2 BSPP	3.00	1.56	1.25	0.74
1/2	SM-501-8FO	3/4-16 ORB	3.16	1.56	1.25	0.70
1/2	SM-501-12FP	3/4-14 NPTF	3.07	1.56	1.37	0.81
1/2	SM-501-12FB	G3/4 BSPP	3.16	1.56	1.37	0.85
3/4	SM-751-12FO	1 1/16-12 ORB	3.89	2.22	1.62	1.78
3/4	SM-751-12FP	3/4-14 NPTF	3.77	2.22	1.62	1.83
3/4	SM-751-12FB	G3/4 BSPP	3.89	2.22	1.62	1.88
3/4	SM-751-16FP	1-11 1/2 NPTF	3.98	2.22	1.62	1.84
3/4	SM-751-16FB	G 1 BSPP	3.98	2.22	1.62	1.89
3/4	SM-751-16FO	1-5/16 - 12 ORB	3.98	2.22	1.62	1.89

Nipple - Female Thread



Body Size	Part Number Steel	Thread Size	Length	Exposed* Length	Largest Diameter	Wrench Flats	Weight (lbs.)
1/4	SM-252-4FP	1/4-18 NPTF	1.49	0.50	0.87	0.75	0.08
1/4	SM-252-4FB	G1/4 BSPP	1.64	0.65	0.87	0.75	0.09
1/4	SM-252-6FP	3/8-18 NPTF	1.64	0.81	1.08	0.94	0.14
1/4	SM-252-6FB	G3/8 BSPP	1.64	0.81	1.08	0.94	0.14
1/4	SM-252-6FO	9/16-18 ORB	1.64	0.55	0.87	0.75	0.08
1/2	SM-502-8FO	3/4-16 ORB	2.14	0.72	1.23	1.06	0.16
1/2	SM-502-8FP	1/2-14 NPTF	2.01	0.45	1.23	1.06	0.15
1/2	SM-502-8FB	G1/2 BSPP	2.01	0.60	1.23	1.06	0.18
1/2	SM-502-12FP	3/4-14 NPTF	2.31	0.90	1.59	1.37	0.30
1/2	SM-502-12FB	G3/4 BSPP	2.63	1.07	1.59	1.37	0.34
3/4	SM-752-12FO	1 1/16-12 ORB	2.60	0.39	1.73	1.50	0.48
3/4	SM-752-12FP	3/4-14 NPTF	2.48	0.39	1.73	1.50	0.52
3/4	SM-752-12FB	G3/4 BSPP	2.60	0.53	1.73	1.50	0.56
3/4	SM-752-16FP	1-11 1/2 NPTF	2.69	0.67	1.88	1.62	0.56
3/4	SM-752-16FB	G 1 BSPP	2.69	0.67	1.88	1.62	0.68
3/4	SM-752-16FO	1-5/16 - 12 ORB	2.69	0.67	1.88	1.62	0.68

* This dimension represents the portion that is exposed when the nipple is inserted into the mating Parker Coupler.



SM Series Dust Caps and Plugs



Body Size	Nipple Dust Cap	Color/Material	Coupler Dust Plug
1/4	N/A	Plastic	PL-25
1/4	CR-25	Black Rubber	PR-25
1/4	C-25	Aluminum	P-25
1/2	DC-50	Black Rubber	DP-50
1/2	C-50	Aluminum	P-50
3/4	C-75	Aluminum	P-75

B Hydraulics



HP Series double shut-off couplings are designed for pressures up to 5000 psi. Couplers and nipples are steel with nitrile seals and are available in 1 and 1-1/2 inch sizes.

Features:

- Rated pressures up to 5000 psi
- Smooth flow path with minimal pressure drop
- Heat treated steel nipple and heavy duty sleeve withstand pressure surges
- Couplings have protective zinc with clear trivalent chromate finish
- Standard end configurations include female pipe and straight thread ORB
- Alternative seal materials available

Applications:

- Industrial hydraulic lines
- Mobile equipment

Performance

HP Series (1" & 1-1/2")
Test Fluid: Oil - 200 SUS

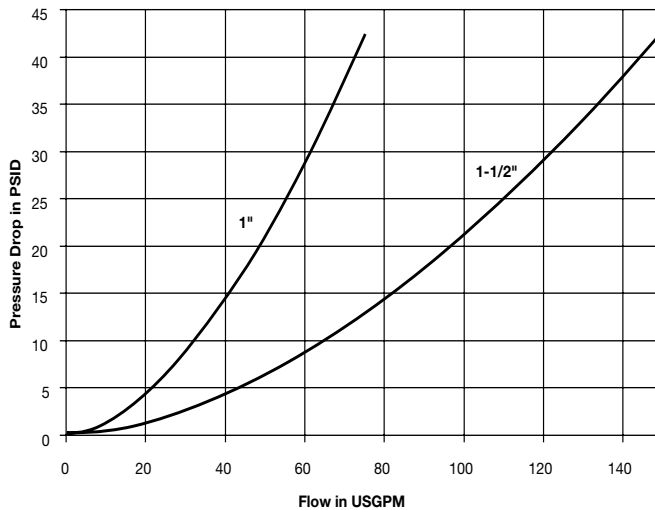

Specifications

Body Size	1	1 - 1/2
Rated Pressure (PSI)	5,000	
Rated Flow (GPM)	50	100
Temperature Range (std seals)	-40° to +250°F	

Optional Seal Materials:

(add code to part number)

Code	Description	Part Number Example
suffix -E5	Ethylene Propylene seal material (EPR)	HP-1001-16FP-E5
suffix -E4	Fluorocarbon seal material	HP-1001-16FP-E4
suffix -E12	Neoprene seal material	HP-1001-16FP-E12

Contact QCD for availability and additional options.

To select proper seal materials, see Fluid Compatibility Chart or contact QCD.



Couplers



Body Size	Part Number	Thread Size	Length	Largest Diameter	Wrench Flats	Weight (lbs.)
1	HP-1001-16FP	1 11-1/2 NPSF	3.95	2.38	1.62	2.10
1	HP-1001-16FO	1 5/16-12 ORB	4.35	2.38	1.62	2.10
1-1/2	HP-1501-24FP	1 1/2-11 1/2 NPTF	4.93	3.00	2.25	4.40
1-1/2	HP-1501-24FO	1 7/8 -12 ORB	4.93	3.00	2.25	4.40

Nipples



Body Size	Part Number	Thread Size	Overall Length	Exposed* Length	Largest Diameter	Wrench Flats	Weight (lbs.)
1	HP-1002-16FP	1 11-1/2 NPSF	3.00	1.32	1.88	1.62	0.84
1	HP-1002-16FO	1 5/16-12 ORB	3.40	1.72	1.88	1.62	0.84
1-1/2	HP-1502-24FP	1 1/2-11 1/2 NPTF	4.06	0.99	2.63	2.25	1.85
1-1/2	HP-1502-24FO	1 7/8-12 ORB	4.06	0.99	2.63	2.25	1.85

* This dimension represents the portion that is exposed when the nipple is inserted into the mating Parker Coupler.

Dust Plugs and Caps



Protective Plugs for Coupler			Protective Caps for Nipple		
P/N	Material	Fits Coupler	P/N	Material	Fits Nipple
HPP-100	Aluminum	HP-1001	HPC-100	Aluminum	HP-1002
HPP-150	Aluminum	HP-1501	HPC-150	Aluminum	HP-1502

Hydraulic Quick Couplings

General Purpose

4000 Series
Accepts ISO 5675 Nipples (1/2" size)
 Manual sleeve, poppet/ball valve



The 4000 Series brings to the industry a proven design for use on agricultural machinery and other rugged applications.

Features:

- 1/2" size accepts ISO 5675 universal tips
- Basic operation where coupler sleeve is manually retracted to allow connection with male tip
- Critical parts are hardened
- Ball and poppet valve options
- Protective zinc plating with clear trivalent chromate finish

Applications include:

- Hydraulic Loaders
- Add-on hydraulic circuits
- Hydraulic tools

B Hydraulics

4000 Series Specifications:						
Body Size	Rated Flow (gpm)	Rated Pressure (psi)	Temperature	Body Material	Sleeve Type	Seal Material
1/4	3	3000	-40° F to +250° F	Steel	Manual Connect	Nitrile
3/8	6					
1/2	12					
3/4	28					
1	50					

Performance:

4000 Series (1/4", 3/8", 1/2")
 Test Fluid: Oil - 200 SUS

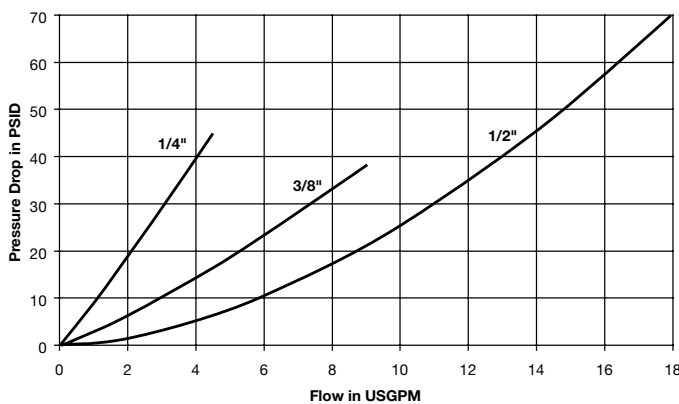

4000 Series (3/4" & 1")
 Test Fluid: Oil - 200 SUS

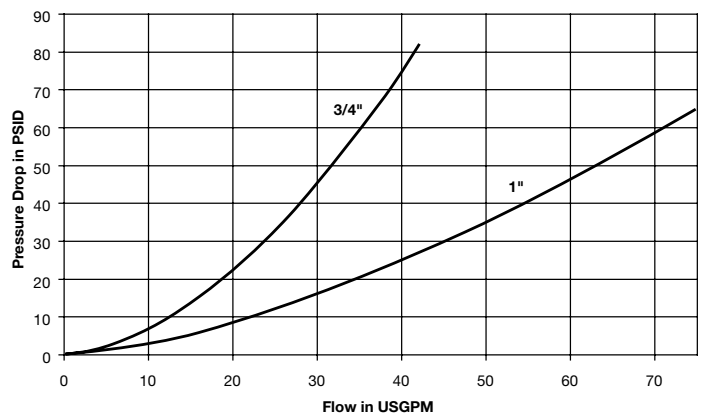

Optional Seal Materials:

(add code to part number)

Code	Description	Part Number Example
suffix W	Ethylene Propylene seal material- EPR	4050-4PW
suffix Y	Fluorocarbon seal material	4050-4PY
suffix Z	Neoprene seal material	4050-4PZ

Contact QCD for availability and additional options.
 To select proper seal materials, see Fluid Compatibility Chart or contact QCD.





4000 Series Couplers



Body Size	Coupler Part Number	Port End	Valve Type	Length	Largest Diameter	Wrench Flats	Weight (lbs.)
1/4	4050-2P	1/4-18 NPTF	Poppet	2.18	1.06	0.88	0.24
1/4	4050-2P-T8M	3/4-16 ORB (Male)	Poppet	1.80	1.06	0.88	0.21
1/4	4050-T6	9/16-18 ORB	Poppet	2.18	1.06	0.88	0.27
1/4	4050P-T6*	9/16-18 ORB	Poppet	2.43	1.33	0.88	0.33
3/8	4050-3P	3/8-18 NPTF	Poppet	2.31	1.33	0.94	0.51
1/2	4050-4	1/2-14 NPTF	Ball	2.60	1.50	1.06	0.58
1/2	4050-4P	1/2-14 NPTF	Poppet	2.60	1.50	1.06	0.58
1/2	4050-5	3/4-14 NPTF	Ball	2.69	1.50	1.13	0.71
1/2	4050-5P	3/4-14 NPTF	Poppet	2.69	1.50	1.13	0.71
1/2	4050-15	3/4-16 ORB	Ball	2.81	1.50	1.06	0.64
1/2	4050-15P	3/4-16 ORB	Poppet	2.81	1.50	1.06	0.64
1/2	4050-16	7/8-14 ORB	Ball	2.75	1.50	1.06	0.59
1/2	4050-16P	7/8-14 ORB	Poppet	2.75	1.50	1.06	0.59
1/2	4050-29BSPP	1/2-14 BSPP	Ball	2.68	1.50	1.06	0.59
3/4	4150-5	3/4-14 NPTF	Ball	3.06	1.87	1.38	1.00
1	4050-6P	1-11 1/2 NPTF	Poppet	3.84	2.08	1.63	1.89

* Special Push/Pull Sleeve

8010 Series Nipples



Body Size	Nipple Part Number	Port End	Valve Type	Length	Exposed Length*	Largest Diameter	Wrench Flats	Weight (lbs.)
1/4	4010-2P	1/4-18 NPTF	Poppet	1.48	0.71	0.87	0.75	0.08
1/4	4010-T6	9/16-18 ORB	Poppet	1.60	0.81	0.87	0.75	0.09
3/8	4010-3P	3/8-18 NPTF	Poppet	1.60	0.80	1.08	0.94	0.16
1/2	8010-4	1/2-14 NPTF	Ball	1.95	1.09	1.23	1.06	0.20
1/2	8010-4P	1/2-14 NPTF	Poppet	1.95	1.09	1.23	1.06	0.20
1/2	8010-5	3/4-14 NPTF	Ball	2.14	1.28	1.44	1.25	0.25
1/2	8010-5P	3/4-14 NPTF	Poppet	2.14	1.28	1.44	1.25	0.25
1/2	8010-15	3/4-16 ORB	Ball	1.95	1.20	1.23	1.06	0.20
1/2	8010-15P	3/4-16 ORB	Poppet	1.95	1.20	1.23	1.06	0.20
1/2	8010-16	7/8-14 ORB	Ball	1.95	1.18	1.23	1.06	0.25
1/2	8010-16P	7/8-14 ORB	Poppet	1.95	1.18	1.23	1.06	0.25
1/2	8010-29BSPP	1/2-14 BSPP	Ball	1.95	1.09	1.18	1.06	0.25
3/4	4110-5	3/4-14 NPTF	Ball	1.81	1.23	1.52	1.31	0.50
1	4010-6P	1-11 1/2 NPTF	Poppet	2.79	1.49	1.88	1.63	0.62

* This dimension represents the portion of the nipple that is exposed when the nipple and coupler are connected.

B Hydraulics



4050 Series Replacement O-Rings

Body Size	Material	Part Number	Durometer
1/4	Nitrile	50001-113-0260	90
3/8	Nitrile	50001-116-0260	90
1/2	Nitrile	50001-211-0260	90
3/4	Nitrile	50001-215-0010	70
1	Nitrile	50001-218-0260	90

4000 Series Dust Caps and Plugs

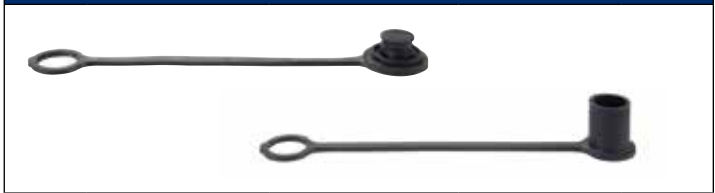

Body Size	Dust Plug (Coupler)	Color/Material	Dust Cap (Nipple)	Weight (lbs.)
1/4	5205-2M	Black Rubber	5209-2M	.02
3/8	5205-3M	Black Rubber	5209-3M	.03
1/2	5205-4M	Black Rubber	5209-4M	.04
1/2	5005-4	Steel w/Chain	5009-4	.21
1/2	5205-4M-BU	Blue Rubber	5209-4M-BU	.04
1/2	5205-4M-GR	Green Rubber	5209-4M-GR	.04
1/2	5205-4M-RE	Red Rubber	5209-4M-RE	.04
1/2	5205-4M-YE	Yellow Rubber	5209-4M-YE	.04
3/4	5205-5M	Black Rubber	5209-5M	.05
1	5205-6M	Black Rubber	5209-6M	.06

Hydraulic Quick Couplings

General Purpose

4200 Series
Accepts ISO 5675 Nipples (1/2" size)
 Push/pull/breakaway sleeve



The 4200 Series brings to the industry a proven design for use on agricultural machinery, construction equipment, and other rugged applications where a breakaway feature is desirable.

Features:

- 1/2" size accepts ISO 5675 universal tips
- Grooves in sleeve to accommodate retaining rings for bulkhead mounting
- One-handed push-to-connect operation when coupler is clamp mounted
- 1/2" body size couplers are compatible with 5001-4 and 5006-4 breakaway clamps
- Critical parts are hardened
- Ball and poppet valve options
- Protective zinc plating with clear trivalent chromate finish

Applications include:

- Hydraulic Loaders
- Add-on hydraulic circuits
- Implement breakaway
- Hydraulic tools

B Hydraulics



4200 Series Specifications:

Body Size	Rated Flow (gpm)	Rated Pressure (psi)	Temperature	Body Material	Sleeve Type	Seal Material
3/8	6	3000	-40° F to +250° F	Steel	Push/pull/ breakaway	Nitrile
1/2	12					

Performance:

4200 Series (3/8" & 1/2")
 Test Fluid: Oil - 200 SUS

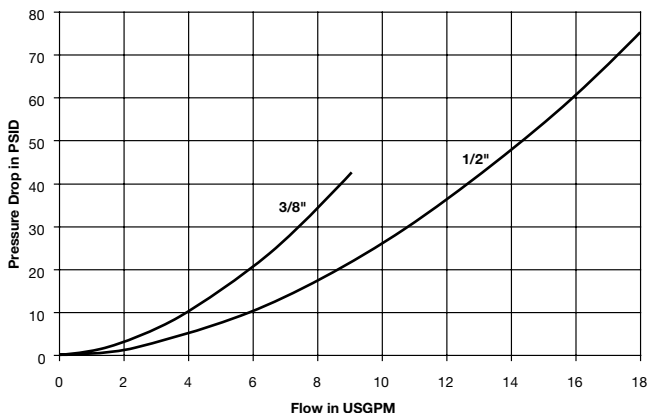

4200 Series Dust Caps and Plugs



Body Size	Dust Plug (Coupler)	Color/Material	Dust Cap (Nipple)	Weight (lbs.)
3/8	5205-3M	Black Rubber	5209-3M	.03
1/2	5205-4M	Black Rubber	5209-4M	.04
1/2	5005-4	Steel w/Chain	5009-4	.21
1/2	5205-4M-BU	Blue Rubber	5209-4M-BU	.04
1/2	5205-4M-GR	Green Rubber	5209-4M-GR	.04
1/2	5205-4M-RE	Red Rubber	5209-4M-RE	.04
1/2	5205-4M-YE	Yellow Rubber	5209-4M-YE	.04

Optional Seal Materials:

(add code to part number)

Code	Description	Part Number Example
suffix W	Ethylene Propylene seal material- EPR	4250-4PW
suffix Y	Fluorocarbon seal material	4250-4PY
suffix Z	Neoprene seal material	4250-4PZ

Contact QCD for availability and additional options.
 To select proper seal materials, see Fluid Compatibility Chart or contact QCD.





4200 Series Couplers



Body Size	Coupler Part Number	Port End	Valve Type	Length	Largest Diameter	Wrench Flats	Weight (lbs.)
3/8	4250-3P	3/8-18 NPTF	Poppet	2.31	1.31	0.81	0.39
1/2	4250-4	1/2-14 NPTF	Ball	2.68	1.50	0.94	0.55
1/2	4250-4P	1/2-14 NPTF	Poppet	2.68	1.50	0.94	0.55
1/2	4250-15	3/4-16 ORB	Ball	2.68	1.50	0.94	0.55
1/2	4250-15P	3/4-16 ORB	Poppet	2.68	1.50	0.94	0.55

8010 Series Nipples



Body Size	Nipple Part Number	Port End	Valve Type	Length	Exposed Length*	Largest Diameter	Wrench Flats	Weight (lbs.)
3/8	4010-3P	3/8-18 NPTF	Poppet	1.60	0.80	1.08	0.94	0.16
1/2	8010-4	1/2-14 NPTF	Ball	1.95	1.09	1.23	1.06	0.20
1/2	8010-4P	1/2-14 NPTF	Poppet	1.95	1.09	1.23	1.06	0.20
1/2	8010-15	3/4-16 ORB	Ball	2.06	1.20	1.23	1.06	0.20
1/2	8010-15P	3/4-16 ORB	Poppet	2.06	1.20	1.23	1.06	0.20

* This dimension represents the portion of the nipple that is exposed when the nipple and coupler are connected.

8010 Series Nipples (Connect Under Pressure)



Body Size	Nipple Part Number	Port End	Valve Type	Length	Exposed Length*	Largest Diameter	Wrench Flats	Weight (lbs.)
1/2	8010-4P-DC	1/2-14 NPTF	DC Poppet	1.81	1.09	1.06	1.16	0.20
1/2	8010-15P-DC	1/2-14 NPTF	DC Poppet	1.81	1.09	1.06	1.16	0.20

4250 Series Replacement O-Rings

Body Size	Material	Part Number	Durometer
3/8	Nitrile	50001-116-0260	90
1/2	Nitrile	50001-211-0260	90



NS Series non-spill couplings are designed to minimize spillage and air inclusion when connecting or disconnecting. Couplers and nipples are steel with nitrile seals. 1/2 inch through 1 inch sizes utilize a PTFE back-up ring as additional support to the interface seal.

Features:

- Rated pressure up to 2500 psi
- Positive valve stop prevents flow checking
- Heat treated steel nipple and heavy duty sleeve withstand pressure surges
- Standard sleeve lock guards against accidental disconnection
- Couplings have protective zinc with clear trivalent chromate finish
- Standard end configurations include female pipe, straight thread ORB, and BSPP
- Alternative seal materials available

Applications:

- Hydraulic hand tools
- Utility equipment
- Mining equipment

Performance

NS Series (3/8" & 1/2")
Test Fluid: Oil - 200 SUS

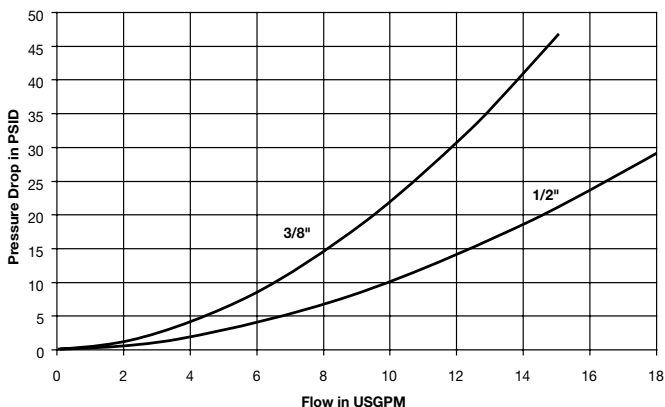

NS Series (3/4" & 1")
Test Fluid: Oil - 200 SUS

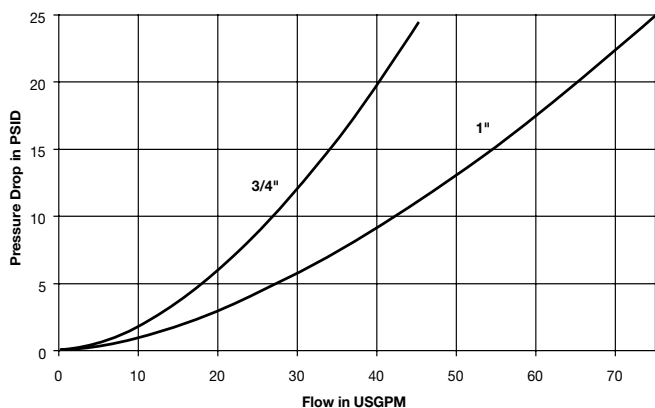

Specifications

Body Size	3/8	1/2	3/4	1
Rated Pressure (psi)	2,500			
Rated Flow (gpm)	10	12	30	50
Temperature Range (std seals)	-40° to +250°F			
Spillage (ml) (max. per disconnect)	0.020	0.070	0.150	0.220
Air Inclusion (ml) (max. per disconnect)	0.010	0.020	0.050	0.070

NS Series Dust Plug/Caps



Body Size	Dust Plug/Cap Rubber
3/8	NR-37
1/2	NR-50
3/4	NR-75
1	NR-100



Couplers



Body Size	Part Number Steel	Thread Size	Length	Largest Diameter	Wrench Flats	Weight (lbs.)
3/8	NS-371-6FP	3/8-18 NPSF	2.10	1.13	1.06	0.36
3/8	NS-371-6FB	G3/8 BSPP	2.10	1.13	1.06	0.38
3/8	NS-371-8FO	3/4-16UNF	2.20	1.13	1.06	0.40
1/2	NS-501-8FP	1/2-14 NPSF	2.88	1.56	1.25	0.84
1/2	NS-501-8FB	G1/2 BSPP	2.95	1.56	1.25	0.74
1/2	NS-501-10FO	7/8-14UNF	2.97	1.56	1.25	0.80
3/4	NS-751-12FP	3/4-14 NPSF	3.19	1.96	1.56	1.48
3/4	NS-751-12FB	G3/4 BSPP	3.38	1.96	1.56	1.54
3/4	NS-751-12FO	1 1/16-12UN	3.51	1.96	1.56	1.58
1	NS-1001-16FP	1-11 1/2 NPSF	3.70	2.25	1.75	2.35
1	NS-1001-16FB	G 1 BSPP	3.81	2.25	1.75	2.36
1	NS-1001-16FO	1 5/16-12UN	3.81	2.25	1.75	2.36

Nipples



Body Size	Part Number Steel	Thread Size	Overall Length	Exposed* Length	Largest Diameter	Wrench Flats	Weight (lbs.)
3/8	NS-372-6FP	3/8-18 NPSF	1.70	1.17	1.08	0.94	0.16
3/8	NS-372-6FB	G3/8 BSPP	1.78	1.25	1.08	0.94	0.16
3/8	NS-372-8FO	3/4-16UNF	1.91	1.38	1.23	1.06	0.20
1/2	NS-502-8FP	1/2-14 NPSF	1.81	0.69	1.23	1.06	0.20
1/2	NS-502-8FB	G1/2 BSPP	1.95	0.83	1.23	1.06	0.22
1/2	NS-502-10FO	7/8-14UNF	2.14	1.02	1.23	1.06	0.23
3/4	NS-752-12FP	3/4-14 NPSF	2.25	1.12	1.59	1.37	0.48
3/4	NS-752-12FB	G3/4 BSPP	2.47	1.34	1.59	1.37	0.54
3/4	NS-752-12FO	1 1/16-12UN	2.62	1.49	1.59	1.37	0.65
1	NS-1002-16FP	1-11 1/2 NPSF	2.64	1.54	1.88	1.62	0.72
1	NS-1002-16FB	G 1 BSPP	2.78	1.68	1.88	1.62	0.74
1	NS-1002-16FO	1 5/16-12UN	2.78	1.68	1.88	1.62	0.80

* This dimension represents the portion that is exposed when the nipple is inserted into the mating Parker Coupler.

Standard Port Configurations

- FP** - Female Pipe Thread
- FO** - Female Straight Thread
- FB** - Female British Standard Parallel Pipe

Optional Seal Materials:

(add code to part number)

Code	Description	Part Number Example
suffix -E5	Ethylene Propylene seal material (EPR)	NS-502-8FP-E5
suffix -E4	Fluorocarbon seal material	NS-502-8FP-E4

Contact QCD for availability and additional options.
To select proper seal materials, see Fluid Compatibility Chart or contact QCD.



Parker Non-Spill Adapters were designed to accommodate the widespread use of several coupling types in mobile equipment. These adapters allow the user to adapt between poppet style, (ISO 7241-A), 6600 series couplings and non-spill type, (ISO 16028), FEM series couplings. They are useful where multiple hydraulic attachments are being utilized.

Features:

- Adapts flush, non-spill valving to / from poppet style
- Global interchangeability with other ISO 16028 and ISO 7241-A compliant couplings
- Protective zinc plating with clear trivalent chromate finish

Applications include:

- Skid loader attachments

Performance

FEM/FF to 6600 Adapter (1/2")
Test Fluid: Oil - 200 SUS

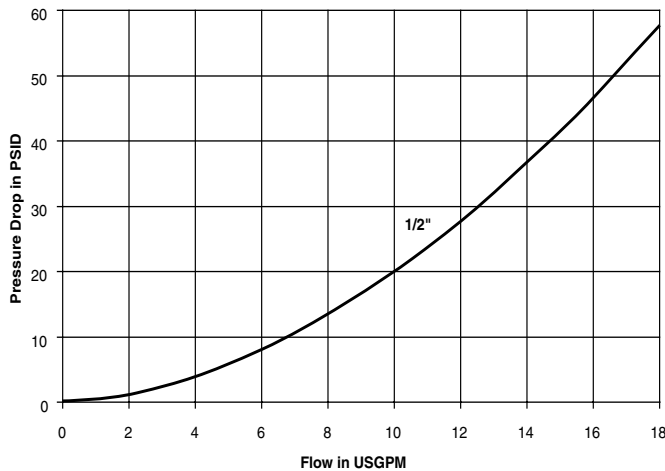

How To Order

Adapter Part Number

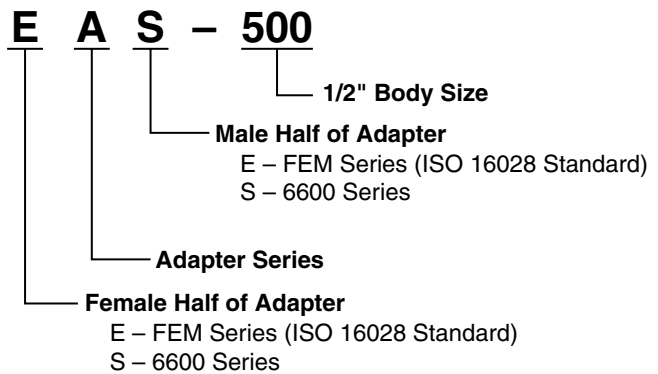

Specifications

Body Size	Rate Pressure (psi)	Rated Flow (gpm)	Temperature Range	Flush Face End Spillage (ml) max. per disconnect	Flush Face End Air Inclusion (ml) max. per connect
1/2	3625	12	-40° to +250° F	.020	.070

Adapters



Body Size	Part Number	Thread Size	Length	Wrench Flats	Largest Diameter
1/2	EAS-500	N/A	3.36	1.38	1.50
1/2	SAE-500	N/A	3.00	1.25	1.48

Hydraulic Quick Couplings Non-Spill

FF/FC Series HTMA (3/8 size) Push to connect/sleeve lock



FF Series couplings eliminate spillage and air inclusion when connecting and disconnecting. The sleeve locking mechanism prevents accidental disconnection. 3/8" body size complies with Hydraulic Tool Manufacturers Association standards. FC nipples provide a connect-under-pressure option for trapped pressures up to 3000 psi on the nipple side.

Features

- Flush, non-spill valving
- Hardened steel sleeves and nipple bodies
- Locking sleeve
- Blow-out resistant seal
- Connect-under-pressure FC nipple option
- Protective zinc plating with clear trivalent chromate finish

Applications include:

- Hydraulic tools
- Mobile equipment
- Industrial hydraulics

Performance

FF Series (1/4", 3/8", 1/2")
Test Fluid: Oil - 200 SUS

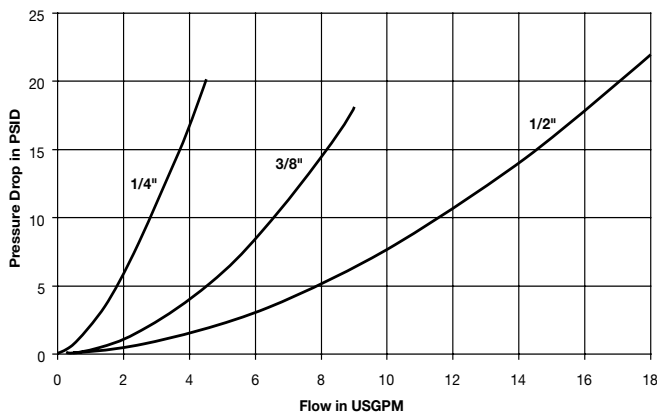

FF Series (3/4" & 1")
Test Fluid: Oil - 200 SUS

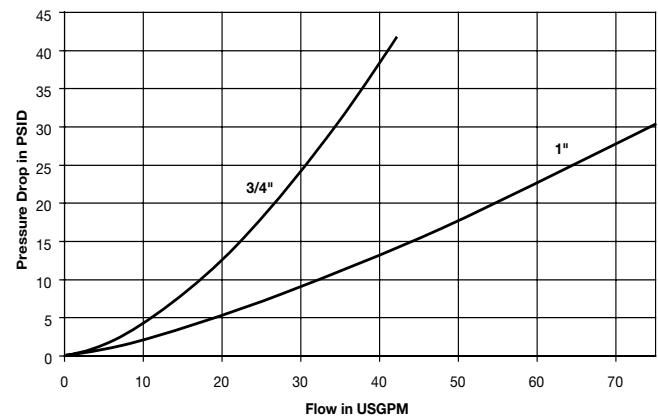

FF Series Specifications

Body Size	Rated Pressure (psi)	Rated Flow (gpm)	Temperature Range	Spillage (ml) max. per disconnect	Air Inclusion (ml) max. per connect	Body Material	Sleeve Type	Seal Material
1/4	5000	3	-40° to +250°F	.015	.020	Steel	Push to Connect	Nitrile/ Polyurethane
3/8	3000	6		.015	.020			
1/2	3000	12		.080	.070			
3/4	3000	28		.150	.100			
1	3000	50		.200	.150			



FF Series Couplers



Body Size	Coupler Part Number	Port End	Length	Largest Diameter	Wrench Flats	Weight (lbs.)
1/4	FF-251-4FP	1/4-18 NPSF	1.79	1.06	1.00	0.23
1/4	FF-251-4MP	1/4-18 NPTF	1.84	1.06	1.00	0.24
1/4	FF-251-6FO	9/16-18 UNF	1.91	1.06	1.00	0.23
3/8	FF-371-6FP	3/8-18 NPSF	2.39	1.20	1.06	0.44
3/8	FF-371-8FP	1/2-14 NPSF	2.80	1.20	1.06	0.50
3/8	FF-371-6FB	G3/8 BSPP	2.45	1.20	1.06	0.45
3/8	FF-371-8FB	G1/2 BSPP	2.80	1.20	1.06	0.48
3/8	FF-371-8FO	3/4-16 UNF	2.82	1.20	1.06	0.52
1/2	FF-501-8FP	1/2-14 NPSF	3.00	1.54	1.25	0.88
1/2	FF-501-10FO	7/8-14 UNF	3.00	1.54	1.25	1.05
3/4	FF-751-12FP	3/4-14 NPSF	3.50	1.94	1.75	1.84
3/4	FF-751-12FO	1 1/16-12 UNF	3.75	1.94	1.75	1.93
1	FF-1001-16FP	1-11 1/2NPSF	4.14	2.25	1.87	2.64
1	FF-1001-16FO	1 5/16-12UNF	4.24	2.25	1.87	2.68

FF Series Nipples



Body Size	Nipple Part Number	Port End	Length	Exposed Length*	Largest Diameter	Wrench Flats	Weight (lbs.)
1/4	FF-252-4FP	1/4-18 NPSF	1.66	1.15	1.06	1.00	0.16
1/4	FF-252-4MP	1/4-18 NPTF	1.72	1.18	1.06	1.00	0.26
1/4	FF-252-6FO	9/16-18 UNF	1.66	1.15	1.06	1.00	0.16
3/8	FF-372-6FP	3/8-18 NPSF	2.31	1.71	1.08	0.94	0.26
3/8	FF-372-8FP	1/2-14 NPSF	2.64	2.04	1.19	1.06	0.32
3/8	FF-372-6FB	G3/8 BSPP	2.45	1.86	1.08	0.94	0.28
3/8	FF-372-8FB	G1/2 BSPP	2.70	2.16	1.19	1.06	0.32
3/8	FF-372-8FO	3/4-16 UNF	2.70	2.16	1.19	1.06	0.3
1/2	FF-502-8FP	1/2-14 NPSF	2.75	2.11	1.38	1.25	0.42
1/2	FF-502-10FO	7/8-14 UNF	2.75	2.07	1.38	1.25	0.44
3/4	FF-752-12FP	3/4-14 NPSF	3.38	2.47	1.73	1.50	1.00
3/4	FF-752-12FO	1 1/16-12 UNF	3.58	2.47	1.73	1.50	1.02
1	FF-1002-16FP	1-11 1/2 NPSF	3.85	2.60	2.17	1.87	1.60
1	FF-1002-16FO	1 5/16-12UNF	3.85	2.60	2.17	1.87	1.70

Standard Port Configurations: **FP** - Female Pipe Thread **FO** - Female Straight Thread
MP - Male Pipe Thread **FB** - Female British Standard Pipe Parallel

* This dimension represents the portion of the nipple that is exposed when the nipple and coupler are connected.



Optional Seal Materials:

(add code to part number)

Code	Description	Part Number Example
suffix -E5	Ethylene Propylene seal material (EPR)	FF-501-8FP-E5
suffix -E4	Fluorocarbon seal material	FF-501-8FP-E4

Optional seals include O-ring & Back-Up Ring, not Anti-Blow Out bonded seal. Contact QCD for availability and additional options. To select proper seal materials, see Fluid Compatibility Chart or contact QCD.

FF Series Repair Kits				Spline Tool
1/4" Nipple	FF-252-KIT	FF-252-KIT-E4	FF-252-KIT-E5	-
1/4" Coupler	FF-251-KIT	FF-251-KIT-E4	FF-251-KIT-E5	FF/FS-251-TOOL
3/8" Nipple	FF-372-KIT	FF-372-KIT-E4	FF-372-KIT-E5	-
3/8" Coupler	FF-371-KIT	FF-371-KIT-E4	FF-371-KIT-E5	FF/FS-371-TOOL
3/4" Nipple	FF-752-KIT	FF-752-KIT-E4	FF-752-KIT-E5	-
3/4" Coupler	FF-751-KIT	FF-751-KIT-E4	FF-751-KIT-E5	FF/FS-751-TOOL
1" Nipple	FF-1002-KIT	FF-1002-KIT-E4	FF-1002-KIT-E5	-
1" Coupler	FF-1001-KIT	FF-1001-KIT-E4	FF-1001-KIT-E5	FF/FS-1001-TOOL

Dust Caps - FF Series			
	Body Size	Coupler Dust Cap - Rubber	Nipple Dust Cap - Rubber
	1/4	FR-25	FR-25
	3/8	NR-50	NR-37
	1/2	FR-501	FR-502
	3/4	FR-751	FR-752
	1	FR-1001	FR-1002



Connect Under Pressure Operation

FC Series products operate slightly different from traditional non-spill couplings. With no pressure in the coupler and up to 3000 PSI of trapped pressure in the nipple, begin to couple the mating halves. Delay momentarily during connection to allow trapped pressure to equalize with the mating half before completing the connection.

FC Series nipples provide a connect-under-pressure option for trapped pressures up to 3000 psi on the nipple side.

Features:

- Connect-under-pressure nipple
- Flush, non-spill valving
- Hardened locking surface
- Blow-out resistant seal
- Protective zinc plating with clear trivalent chromate finish

Applications include:

- Hydraulic tools

FC Series Specifications

Body Size	Rated Pressure (psi)	Rated Connect-Under-Pressure Capability	Rated Flow (gpm)	Spillage (ml) max. per disconnect	Air Inclusion (ml) max. per connect
3/8	3000	3000	6	.015	.020
1/2	3000	3000	12	.020	.070
3/4	3000	1500	26	.150	.100

Performance

FC Series (3/8", 1/2", 3/4")
Test Fluid: Oil - 200 SUS

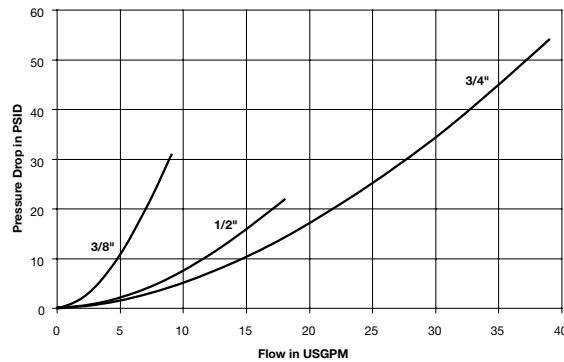

FC Series Connect Under Pressure Nipples



Body Size	Part Number	Mating Half	Port End	Length	Exposed Length*	Largest Diameter	Wrench Flats	Weight (lbs.)
3/8	FC-372-6FP	FF-371	3/8-18 NPSF	3.30	2.58	1.16	1.062	0.45
3/8	FC-372-8FO	FF-371	3/4-16 UNF	3.30	2.58	1.16	1.062	0.42
3/8	FC-372-8FP	FF-371	1/2-14 NPSF	3.30	2.58	1.16	1.062	0.42
1/2	FC-502-8FP	FF-501	1/2-14 NPSF	3.46	2.65	1.22	1.125	0.53
1/2	FC-502-10FO	FF-501	7/8-14 UNF	3.46	2.65	1.22	1.125	0.52
3/4	FC-752-12FO	FF-751	1 1/16-12 UNF	4.81	3.72	1.65	1.500	1.32
3/4	FC-752-12FP	FF-751	3/4-14 NPSF	4.81	3.72	1.65	1.500	1.34

Standard Port Configurations: FP - Female Pipe Thread FO - Female Straight Thread

* This dimension represents the portion of the nipple that is exposed when the nipple and coupler are connected.



FEM Series couplings meet or exceed ISO 16028 design and performance requirements. The flush valves eliminate spillage and air inclusion when connecting and disconnecting. Coupler and nipple bodies have a modular design with increased flexibility for end port options. FEC nipples provide a connect-under-pressure option for trapped residual pressure.

Features

- Flush, non-spill valving
- Global interchangeability with other ISO 16028 compliant couplings
- Hardened steel sleeves and nipple bodies
- Optional locking sleeve
- Connect-under-pressure FEC nipple option
- Protective zinc plating with clear trivalent chromate finish

Applications include:

- Skid loader attachments
- Hydraulic tools

Materials of Construction

Body: Steel
Finish: Zinc with clear trivalent chromate
Valve: Flush face valving
Seal: Polyurethane and Nitrile

Performance

FEM Series (1/4", 3/8" & 1/2")
Test Fluid: Oil - 150 SUS

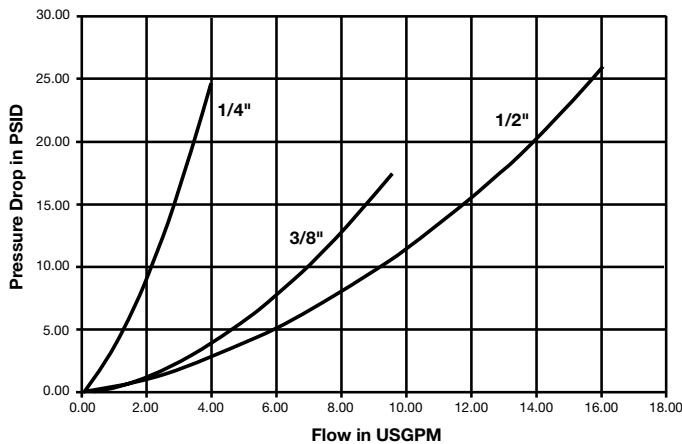

FEM Series (5/8", 3/4" & 1")
Test Fluid: Oil - 150 SUS

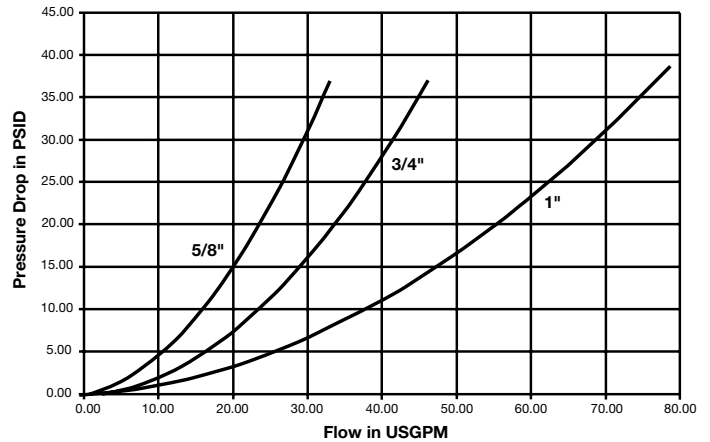

FEM Series Specifications

Body Size	Rated Pressure (psi)	Rated Flow (gpm)	Temperature Range	Spillage (ml) max. per disconnect	Air Inclusion (ml) max. per connect	Body Material	Sleeve Type	Seal Material
1/4	4568	3	-22° to +212°F	.015	.020	Steel	Push to Connect	Polyurethane and Nitrile
3/8	3625	6		.015	.020			
1/2	3625	12		.020	.070			
5/8	3625	20		.030	.070			
3/4	3625	26		.150	.100			
1	2900	50		.200	.150			



FEM Series Couplers



Body Size	Coupler Part Number	Port End	Length	Coupled Length (when connected to corresponding nipple)	Largest Diameter	Wrench Flats	Weight (lbs.)
1/4	FEM-251-4FP-NL	1/4-18 NPSF	1.96	3.98	1.16	27mm	0.52
1/4	FEM-251-6FO-NL	9/16-18 UNF	2.08	4.06	1.16	27mm	0.51
3/8	FEM-371-6FP-NL	3/8-18 NPSF	2.89	4.43	1.26	30mm	0.68
3/8	FEM-371-8FO-NL	3/4-16 UNF	2.89	4.67	1.26	30mm	0.68
1/2	FEM-501-8FP-NL	1/2-14 NPSF	2.96	5.09	1.54	1.25	0.93
1/2	FEM-501-8FO-NL	3/4-16 UNF	2.96	5.09	1.54	1.25	0.93
1/2	FEM-501-10FO-NL	7/8-14 UNF	2.96	5.09	1.54	1.25	0.93
1/2	FEM-501-12FO-NL	1 1/16-12 UNF	3.21	5.59	1.54	1.25	0.93
5/8	FEM-621-12FO-NL	1 1/16-12 UNF	3.70	5.64	1.69	40mm	1.34
3/4	FEM-751-12FP-NL	3/4-14 NPSF	3.95	6.00	1.97	46mm	1.98
3/4	FEM-751-12FO-NL	1 1/16-12 UNF	3.95	6.20	1.97	46mm	2.00
1	FEM-1001-16FP-NL	1-11 1/2-NPSF	4.21	6.79	2.36	55mm	3.08
1	FEM-1001-16FO-NL	1 5/16-12 UNF	4.21	6.79	2.36	55mm	3.03

FEM Series Couplers (Bulkhead)



Body Size	Coupler Part Number	Port End	Length	Coupled Length (when connected to corresponding nipple)	Largest Diameter	Wrench Flats	Weight (lbs.)
1/2	FEM-501-10BMF-NL	7/8-14 UNF	4.04	7.24	1.54	1.25	1.13
1/2	FEM-501-10BMS-NL	1-14 UNS	4.04	7.24	1.54	1.25	1.13

Code	Description	Part Number Example
suffix -E5	Ethylene Propylene seal material (EPR)	FEM-501-8FP-NL-E5
suffix -E4	Fluorocarbon seal material	FEM-501-8FP-NL-E4

Contact QCD for availability and additional options.
To select proper seal materials, see Fluid Compatibility Chart or contact QCD.



FEM Series Nipples



Body Size	Nipple Part Number	Port End	Length	Coupled Length (when connected to corresponding coupler)	Largest Diameter	Wrench Flats	Weight (lbs.)
1/4	FEM-252-4FP	1/4-18 NPSF	1.71	3.98	0.96	22mm	0.20
1/4	FEM-252-6FO	9/16-18 NPSF	1.95	4.06	0.96	22mm	0.19
3/8	FEM-372-6FP	3/8-18 NPSF	2.48	4.43	1.26	30mm	0.40
3/8	FEM-372-8FO	3/4-16 UNF	2.48	4.67	1.26	30mm	0.41
1/2	FEM-502-8FP	1/2-14 NPSF	2.77	5.09	1.38	1.25	0.54
1/2	FEM-502-8FO	3/4-16 UNF	2.77	5.09	1.38	1.25	0.54
1/2	FEM-502-10FO	7/8-14 UNF	2.77	5.09	1.38	1.25	0.54
1/2	FEM-502-12FO	1 1/16-12 UN	3.02	5.59	1.38	1.25	0.54
5/8	FEM-622-12FO	1 1/16-12 UN	3.09	5.64	1.57	36mm	0.72
3/4	FEM-752-12FP	3/4-14 NPSF	3.38	6.00	1.97	46mm	1.17
3/4	FEM-752-12FO	1-1/16 12 UN	3.38	6.20	1.974	46mm	1.20
1	FEM-1002-16FP	1-11 1/2 NPSF	3.85	6.79	2.36	55mm	1.94
1	FEM-1002-16FO	1-5/16 12 UN	3.85	6.79	2.36	55mm	1.90

FEM Series Nipples (Bulkhead)



Body Size	Nipple Part Number	Port End	Length	Coupled Length (when connected to corresponding nipple)	Largest Diameter	Wrench Flats	Weight (lbs.)
1/2	FEM-502-10BMF	7/8-14 UNF	3.85	7.24	1.38	1.25	.84
1/2	FEM-502-10BMS	1-14 UNS	3.85	7.24	1.38	1.25	.84

Standard Port Configurations: **FP** - Female Pipe Thread **FO** - Female Straight Thread **BMF** - Bulkhead Flare **BMS** - Bulkhead Face Seal

Other Fitting Port Configurations available upon request.

* This dimension represents the portion of the nipple that is exposed when the nipple and coupler are connected.

Dust Caps - FEM Series



Body Size	Nipple Dust Cap	Coupler Dust Cap	Material
1/4	CFE-252-PN	PFE-251-PN	PVC
3/8	CFE-372-PN	PFE-371-PN	PVC
1/2	CFE-502-PN	PFE-501-PN	PVC
5/8	CFE-622-PN	PFE-621-PN	PVC
3/4	CFE-752-PN	PFE-751-PN	PVC
1	CFE-1002-PN	PFE-1001-PN	PVC



Applications

Parker FEC Series nipple provide connect-under-pressure capability with up to 3000 PSI of trapped pressure in the nipple and are ideal for applications where residual pressure makes reconnect difficult. Utilized primarily in the construction equipment market, FEC Series products are commonly found on hydraulic attachments used in skid steer applications. The FEC Series mates with the FEM Series interface ISO 16028 couplers.

Features:

- Connect-Under-Pressure nipple
- Hardened locking surface
- Steel construction, Chromium-6 Free plating for corrosion resistance
- Anti blowout bonded nipple seal
- Flush face valving

Connect Under Pressure Operation

FEC Series products operate slightly different from traditional non-spill couplings. With no pressure in the coupler and up to 3000 PSI of trapped pressure in the nipple, begin to couple the mating halves. Delay momentarily during connection to allow trapped pressure to equalize with the mating half before completing the connection.

Performance

FEC Series (1/2", 5/8", 3/4")
Test Fluid: Oil - 200 SUS

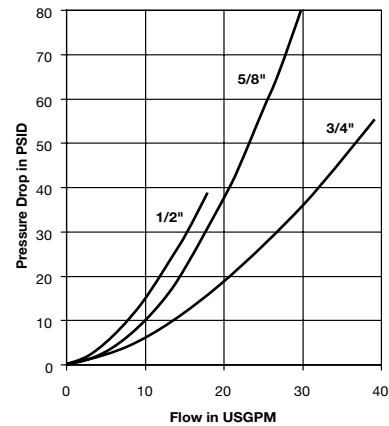

FEC Series Specifications					
Body Size	Rate Pressure (psi)	Rated Connect-Under-Pressure Capability	Rated Flow (gpm)	Spillage (ml) max. per disconnect	Air Inclusion (ml) max. per connect
1/2	3625	3000	12	.020	.070
5/8	3625	1700	20	.003	.070
3/4	3625	1500	26	.150	.100

FEC Series Connect Under Pressure Nipples



Body Size	Part Number	Mating Half	Port End	Length	Coupled Length (when connected to corresponding nipple)	Largest Diameter	Wrench Flats	Weight (lbs.)
1/2	FEC-502-8FP	FEM-501	1/2-14 NPSF	3.50	5.82	1.22	1.125	-
1/2	FEC-502-10FO	FEM-501	7/8-14 UNF	3.50	5.82	1.22	1.125	-
1/2	FEC-502-12FO	FEM-501	1 1/16-12 UNF	3.79	6.36	1.65	1.500	-
5/8	FEC-622-12FO	FEM-621	1 1/16-12 UN	3.39	5.94	1.65	1.500	-
3/4	FEC-752-12FO	FEM-751	1 1/16-12 UN	3.76	6.58	1.65	1.500	-

Standard Port Configurations: FP - Female Pipe Thread FO - Female Straight Thread

* This dimension represents the portion of the nipple that is exposed when the nipple and coupler are connected.



FH Series high pressure, non-spill couplings have flush valves and are designed to minimize spillage and air inclusion when connecting or disconnecting. Couplers and nipples are steel with nitrile seals. Available in 3/8 inch size only, with red finish for easy identification. Will not connect with lower pressure flush face couplings.

Features:

- Rated pressure up to 10,000 psi
- Push to connect operation
- Red finish on nipple body and coupler sleeve
- Standard sleeve lock guards against accidental disconnection
- Not interchangeable with lower pressure flush face couplings
- Standard end configurations include female pipe, male pipe, and BSPP threads
- Alternative seal materials available

Applications:

- Hydraulic crimpers, cutters, benders, clamps, wedges
- Rescue equipment
- High pressure test equipment

Performance

FH Series (3/8")
Test Fluid: Oil - 200 SUS

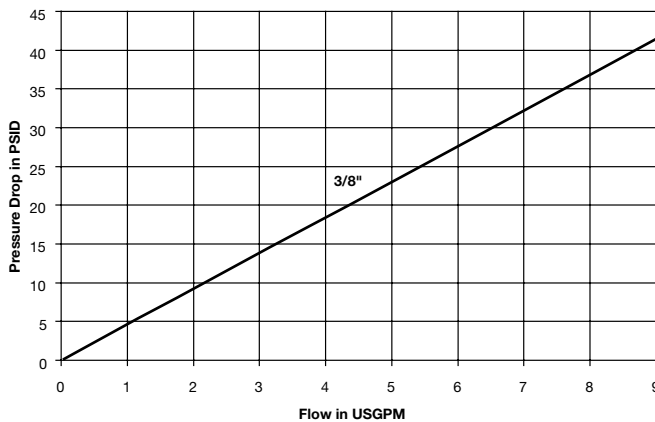

Specifications

Body Size	3/8
Rated Pressure (PSI)	10,000
Rated Flow (GPM)	6
Temperature Range	-40° to +250° F
Spillage (ML) (max. per disconnect)	.020
Air Inclusion (ML) (max. per connect)	.070

Materials of Construction

Body	Steel
Finish	Chromium-6 Free plating
Valve	Flush Face Valves
Seal	Anti blow-out Nitrile/PTFE bonded seal (nipple only)

Optional Seal Materials:

(add code to part number)

Code	Description	Part Number Example
suffix -E5	Ethylene Propylene seal material (EPR)	FH-371-6FP-E5
suffix -E4	Fluorocarbon seal material	FH-371-6FP-E4

Optional seals include O-ring & Back-Up Ring, not Anti-Blow Out bonded seal. Contact QCD for availability and additional options. To select proper seal materials, see Fluid Compatibility Chart or contact QCD.



Couplers



Body Size	Part Number Steel	Thread Size	Length	Largest Diameter	Wrench Flats	Weight (lbs.)
3/8	FH-371-6FP	3/8 -18 NPTF	2.63	1.23	1.12	0.44
3/8	FH-371-6MP	3/8 -18 NPTF	2.85	1.23	1.12	0.45
3/8	FH-371-6FB	G3/8 -BSPP	2.63	1.23	1.12	0.45

Nipples



Body Size	Part Number Steel	Thread Size	Length	Largest Diameter	Wrench Flats	Weight (lbs.)
3/8	FH-372-6FP	3/8-18 NPTF	2.12	1.23	1.00	0.26
3/8	FH-372-6FB	G3/8 -BSPP	2.12	1.23	1.00	0.28

Standard Port Configurations: **FP** - Female Pipe Thread **MP** - Male Pipe Thread **FB** - Female British Parallel Pipe

FH Series Dust Caps



Body Size	Coupler Dust Cap - Rubber	Nipple Dust Cap - Rubber
3/8	NR-50	NR-37



FS Series dry disconnect couplings are ideal for closed system transfer and dispensing of chemicals and other fluids. The flush valves eliminate spillage and air inclusion when connecting and disconnecting to result in minimal environmental contamination.

Features:

- Flush, non-spill valves enable ease of cleaning
- 316 stainless steel material for chemical compatibility
- Push to connect operation
- Fluorocarbon standard seal material with options available

Applications include:

- Chemical dispensing systems
- Chemical processing
- Food processing
- Corrosive media transfer

Materials of Construction

- Machined Parts:** Stainless Steel, AISI type 316
Springs: Stainless Steel, AISI type 316.
Locking Balls: 1/4 - 3/8": 302 SS;
 1/2 - 3/4": 316 SS
 1": 440 SS
Backup Washers: PTFE
Elastomer Seals: Fluorocarbon is standard.
 Wide range is available.

Specifications					
Body Size	Rated Pressure (psi)	Rated Flow (gpm)	Spillage (ml) max. per disconnect	Air Inclusion (ml) max. per connect	CV
1/4	2000	3	.015	.010	0.90
3/8	2000	6	.015	.020	1.80
1/2	2000	12	.020	.070	3.00
3/4	2000	28	.150	.100	7.00
1	2000	50	.250	.182	10.1

Temperature Range (continuous)		
Part No. Seal Suffix	Seal Compound	Temp° F Rating
None*	Fluorocarbon	-15 to 400
E5	Ethylene Propylene (EPR)	-65 to 300
E1	Nitrile	-40 to 250
E35	Perfluoroelastomer (Contact QCD)	-20 to 600

*Fluorocarbon is standard seal.
 Contact QCD for availability and additional options.
 To select proper seal materials, see Fluid Compatibility Chart or contact QCD.

Optional Seal Materials:

Code	Description	Part Number Example
suffix -E5	Ethylene Propylene seal material- EPR)	FS-371-6FP-E5
suffix -E12	Neoprene seal material	FS-371-6FP-E12

Performance Flow Data

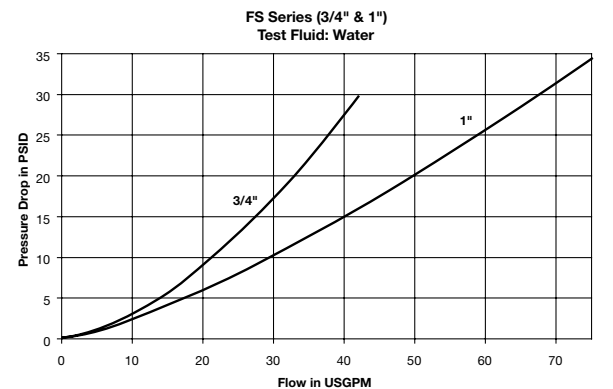
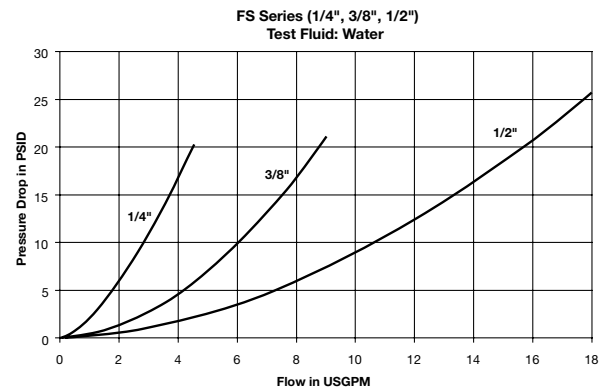



FS Series Couplers - Female Thread



Body Size	Coupler Part Number	Port End	Length	Largest Diameter	Wrench Flats	Weight (lbs.)
1/4	FS-251-4FP	1/4-18 NPT	1.79	1.06	1.00	0.25
1/4	FS-251-4MP	1/4-18 NPTF	2.00	1.06	1.00	0.25
1/4	FS-251-6FO	9/16-18UNF	1.92	1.06	1.00	0.24
3/8	FS-371-6FP	3/8-18 NPT	2.52	1.30	1.06	0.58
3/8	FS-371-8FO	3/4-16 UNF	2.83	1.30	1.06	0.63
1/2	FS-501-8FP	1/2-14 NPT	2.74	1.58	1.38	0.92
1/2	FS-501-10FO	7/8-14 UNF	2.86	1.58	1.38	0.96
3/4	FS-751-12FP	3/4-14 NPT	3.63	1.99	1.75	2.00
3/4	FS-751-12FO	1-1/16-12 UNF	3.73	1.99	1.75	2.04
1	FS-1001-16FP	1-11 1/2 NPT	4.14	2.25	1.87	2.76
1	FS-1001-16FO	1-5/16-12 UNF	4.24	2.25	1.87	2.80

FS Series Nipples - Female Thread



Body Size	Coupler Part Number	Port End	Overall Length	Exposed Length*	Largest Diameter	Wrench Flats	Weight (lbs.)
1/4	FS-252-4FP	1/4-18 NPT	1.66	1.14	1.06	1.00	0.18
1/4	FS-252-4MP	1/4-18 NPTF	1.87	1.34	1.06	1.00	0.18
1/4	FS-252-6FO	9/16-18 UNF	1.78	1.26	1.06	1.00	0.17
3/8	FS-372-6FP	3/8-18 NPT	2.31	1.71	1.08	0.94	0.26
3/8	FS-372-8FO	3/4-16 UNF	2.45	1.71	1.19	1.06	0.30
1/2	FS-502-8FP	1/2-14 NPT	2.75	2.03	1.30	1.12	0.44
1/2	FS-502-10FO	7/8-14 UNF	2.85	2.11	1.30	1.12	0.48
3/4	FS-752-12FP	3/4-14 NPT	3.38	2.37	1.65	1.50	1.02
3/4	FS-752-12FO	1-1/16-12 UNF	3.38	2.37	1.65	1.50	1.02
1	FS-1002-16FP	1-11 1/2 NPT	3.89	2.60	2.17	1.87	1.60
1	FS-1002-16FO	1-5/16 12 UNF	3.89	2.51	2.17	1.87	1.64

Standard Port Configurations: FP - Female Pipe Thread MP - Male Pipe Thread FO - Female Straight Thread

* This dimension represents the portion of the nipple that is exposed when the nipple and coupler are connected.

Dust Caps - FS Series



Body Size	Coupler Dust Cap - Rubber	Nipple Dust Cap - Rubber
1/4	FR-25	FR-25
3/8	NR-50	NR-37
1/2	FR-501	FR-502
3/4	FR-751	FR-752
1	FR-1001	FR-1002



FS Series Repair Kits

Repair kits are available for both coupler and nipple half of FS coupling. Kits include replacement elastomer seals, valve assembly and instructions to perform rebuild. Spline tool must be ordered separately to accomplish coupler half repair. Other tools required: Vise, Allen Wrench and Open End Wrench.

FS Repair Kits		
TOOL Spline tool for Coupler Repair	Replacement Seals	
	No Suffix	Fluorocarbon Seals
	E5	Ethylene Propylene (EPR)
	E35	Perfluoroelastomer (Contact Factory for Seal Options).

Nipple Repair Kits		
1/4	FS-252-KIT	FS-252-KIT-E5
3/8	FS-372-KIT	FS-372-KIT-E5
1/2	FS-502-KIT	FS-502-KIT-E5
3/4	FS-752-KIT	FS-752-KIT-E5
1	FS-1002-KIT	FS-1002-KIT-E5

Coupler Repair Kits			Spline Tool
1/4	N/A	N/A	N/A
3/8	FS-371-KIT	FS-371-E5	FF/FS-371-TOOL
1/2	FS-501-KIT	FS-501-KIT-E5	FS-501-TOOL
3/4	FS-751-KIT	FS-751-KIT-E5	FF/FS-751-TOOL
1	FS-1001-KIT	FS-1001-KIT-E5	FF/FS-751-TOOL



FET Series couplings are built to be used in high pressure, high impulse applications that require the security of a threaded connection and the ability to connect and disconnect under residual pressure. Interchanges with similar European style thread-to-connect couplings.

Features:

- Connect under residual pressure up to 5000 psi
- Disconnect under residual pressure up to 2500 psi
- High impulse resistance
- High strength materials
- FNC coating for extended durability and corrosion resistance
- Visual connection indicator

Applications include:

- Mobile drill rigs
- Oil field equipment
- Umbilical lines
- High impulse mobile circuits
- Excavator attachments



FET Series Specifications

Body Size (inch)	Euro Size	Port End	Rated Pressure (psi)	Temperature Range	Body Material	Sleeve Type	Seal Material
3/8	9	Female ORB	6000	-40° to +250°F	Steel	Thread to Connect	Nitrile/Polyurethane
		Female NPTF	6000				
1/2	13	Female ORB	6000				
		Female NPTF	6000				
5/8	15	Female ORB	5000				
		Female NPTF	5000				
3/4	17	Female ORB	5000				
		Female NPTF	5000				
		Code 62 Flange Head	6000				
		Code 62 Flange Pad	6000				
1	21	Female ORB	3000				
		Female NPTF	5000				
		Code 62 Flange Head	6000				
		Code 62 Flange Pad	6000				
1-1/2	30	Female ORB	2500				
		Female NPTF	3000				
		Code 62 Flange Head	5000				
		Code 62 Flange Pad	5000				

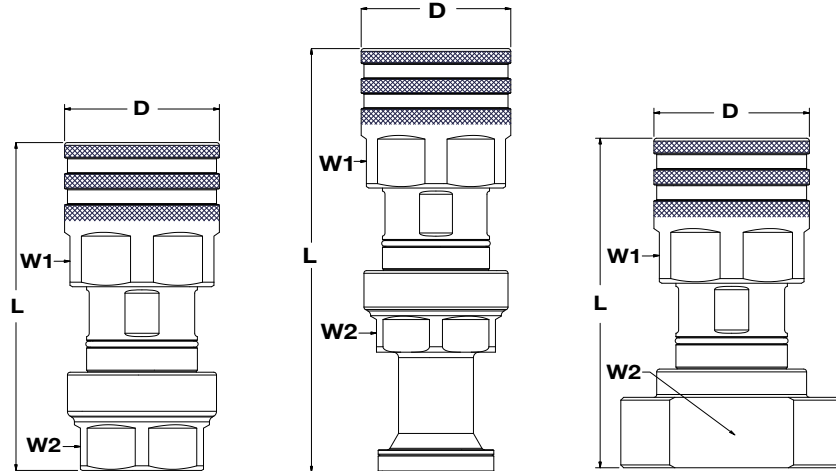

FET Series Couplers



Body Size	Coupler Part Number	Port End	Length (in)	Largest Diameter (in)	Wrench Flats W1	Wrench Flats W2	Weight (lbs.)
3/8	FET-371-8FO	3/4 -16 UNF	3.83	1.65	38 mm	30 mm	0.91
3/8	FET-371-8FP	1/2 -14 NPTF	3.91	1.65	38 mm	30 mm	0.92
1/2	FET-501-10FO	7/8 -14 UNF	3.82	2.05	48 mm	1-1/2 in	1.40
1/2	FET-501-8FP	1/2 -14 NPTF	3.70	2.05	48 mm	1-1/2 in	1.38
5/8	FET-621-12FO	1 1/16 -12 UNF	4.66	2.12	50 mm	1-5/8 in	2.06
5/8	FET-621-12FP	3/4 -14 NPTF	4.52	2.12	50 mm	1-5/8 in	2.03
3/4	FET-751-16FO	1 5/16 -12 UNF	5.44	2.31	55 mm	2 in	3.30
3/4	FET-751-16FP	1 - 11 1/2 NPTF	5.44	2.31	55 mm	2 in	3.35
1	FET-1001-20FO	1 5/8 - 12 UNF	5.83	2.75	65 mm	2-3/16 in	4.72
1	FET-1001-20FP	1 1/4 -11 1/2 NPTF	5.83	2.75	65 mm	2-3/16 in	4.76
1-1/2	FET-1501-24FO	1 7/8 - 12 UNF	7.08	3.75	85 mm	2-5/8 in	10.01
1-1/2	FET-1501-24FP	1 1/2 -11 1/2 NPTF	7.08	3.75	85 mm	2-5/8 in	10.06

FET Series Couplers - Code 62 Flange



Body Size	Coupler Part Number	Port End	Bolt Thread Size	Length (in)	Largest Diameter (in)	Wrench Flats W1 (mm)	Wrench Flats W2 (in)	Weight (lbs.)
3/4	FET-751-16SF	Flange Head	-	7.60	2.31	55	2	4.17
3/4	FET-751-16SFP	Flange Pad	7/16 - 14 UNC	5.45	2.31	55	2-3/4	4.82
1	FET-1001-20SF	Flange Head	-	7.78	2.75	65	2-3/16	5.44
1	FET-1001-20SFP	Flange Pad	1/2 - 13 UNC	5.83	2.75	65	3	6.90
1-1/2	FET-1501-24SF	Flange Head	-	9.83	3.75	85	2-5/8	11.37
1-1/2	FET-1501-24SFP	Flange Pad	5/8 - 11 UNC	6.82	3.75	85	2-5/8	13.31

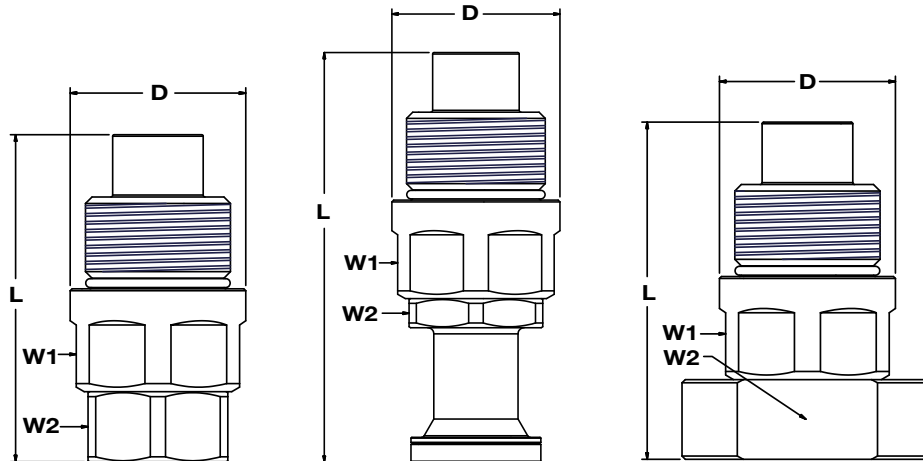

FET Series Nipples



Body Size	Nipple Part Number	Port End	Length (in)	Largest Diameter (in)	Wrench Flats W1	Wrench Flats W2	Weight (lbs.)
3/8	FET-372-8FO	3/4 -16 UNF	3.51	1.60	38 mm	1-1/4 in	0.99
3/8	FET-372-8FP	1/2 -14 NPTF	3.51	1.60	38 mm	1-1/4 in	0.99
1/2	FET-502-10FO	7/8 -14 UNF	3.70	1.88	44 mm	1-1/8 in	1.14
1/2	FET-502-8FP	1/2 -14 NPTF	3.50	1.88	44 mm	1-1/8 in	1.13
5/8	FET-622-12FO	1 1/16 -12 UNF	4.21	2.12	50 mm	1-5/8 in	2.05
5/8	FET-622-12FP	3/4 -14 NPTF	4.08	2.12	50 mm	1-5/8 in	2.02
3/4	FET-752-16FO	1 5/16 -12 UNF	4.72	2.31	55 mm	2 in	2.76
3/4	FET-752-16FP	1 - 11 1/2 NPTF	4.65	2.31	55 mm	2 in	2.72
1	FET-1002-20FO	1 5/8 - 12 UNF	5.12	2.75	65 mm	2-3/16 in	4.31
1	FET-1002-20FP	1 1/4 -11 1/2 NPTF	5.12	2.75	65 mm	2-3/16 in	4.35
1-1/2	FET-1502-24FO	1 7/8 - 12 UNF	5.94	3.75	75 mm	2-5/8 in	7.94
1-1/2	FET-1502-24FP	1 1/2 -11 1/2 NPTF	5.94	3.75	75 mm	2-5/8 in	8.00

FET Series Nipples - Code 62 Flange



Body Size	Nipple Part Number	Port End	Bolt Thread Size	Length (in)	Largest Diameter (in)	Wrench Flats W1 (mm)	Wrench Flats W2 (in)	Weight (lbs.)
3/4	FET-752-16SF	Flange Head	-	6.32	2.31	55	2	3.10
3/4	FET-752-16SFP	Flange Pad	7/16 - 14 UNC	4.74	2.31	55	2-3/4	4.33
1	FET-1002-20SF	Flange Head	-	6.70	2.75	65	2-3/16	4.71
1	FET-1002-20SFP	Flange Pad	1/2 - 13 UNC	5.27	2.75	65	3	6.78
1-1/2	FET-1502-24SF	Flange Head	-	7.77	3.75	75	2-5/8	8.08
1-1/2	FET-1502-24SFP	Flange Pad	5/8 - 11 UNC	5.94	3.75	75	2-5/8	12.17



FET Series Dust Caps and Plugs



Body Size	Nipple Dust Cap	Coupler Dust Plug
3/8	FET3DC-01	FET3DP-01
1/2	FET5DC-01	FET5DP-01
5/8	FET6DC-01	FET6DP-01
3/4	FET7DC-01	FET7DP-01
1	FET10DC-01	FET10DP-01
1-1/2	FET15DC-01	FET15DP-01

Hydraulic Quick Couplings

Connect Under Pressure

6100 Series

Threaded Connection

Flush valves, high flow



6100 Series is a thread to connect, low spill coupling that can be connected under pressure. Coupler and nipple bodies are corrosion resistant brass. Couplers are available with a steel hex nut or heavy duty wing nut sleeve. A connection indicator groove on the nipple body indicates when the connection is complete and the valves are fully open.

Features:

- Rated pressures up to 3000 psi
- Thread to connect operation
- Bonded valve seal stays in place under full pressure connect and disconnect
- Visual connection indicator
- Rugged wing nut sleeve will withstand hammering to tighten or loosen
- Optional flange for secure bulkhead mounting
- Standard end configuration is female pipe thread
- Special part numbers apply for CO2 transfer (contact QCD)

Applications:

- Submersible pumps
- Oil field equipment
- Dump trailers
- Engine test stands
- Bulk liquid transfer

Performance

6100 Series (1/2" & 3/4")
Test Fluid: OIL 150 SUS

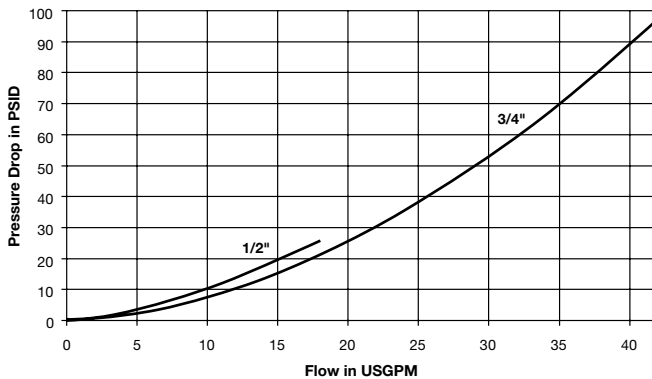

6100 Series (1", 1-1/4", 1-1/2")
Test Fluid: OIL 150 SUS

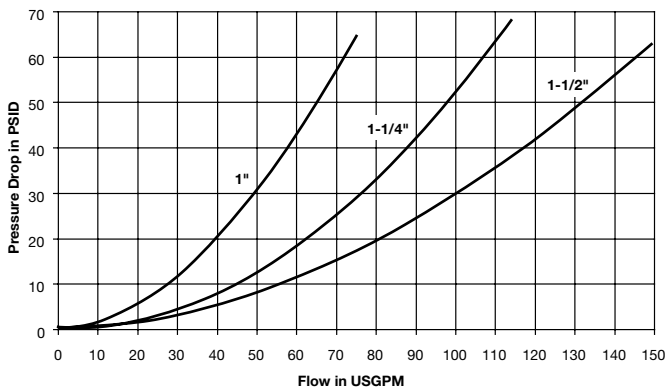

Specifications

Body Size	3/4	3/4	1	1 - 1/4	1 - 1/2
Dash Number	-08	-12	-16	-20	-24
Rated Pressure (psi) *					
Female Half	3,000	3,000	3,000	2,750	2,000
Male Half	3,000	3,000	3,000	2,500	2,500
Complete Coupling Assembly	3,000	3,000	3,000	2,750	2,500
Rated Flow (gpm)	12	28	50	76	100
Temperature Range (std seals)	-40° to +250°F				

* Not recommended for continuous hydraulic impulse applications at rated pressures.



Coupling Set with Wingnut



Body Size	Part Number With Flange	Part Number Without Flange	Thread Size	Overall Connected Length	Weight (lbs.)
3/4	6100-08	6120-08	1/2-14 NPTF	5.20	2.12
3/4	6100-12	6120-12	3/4-14 NPTF	5.32	2.00
1	6100-16	6120-16	1-11 1/2 NPTF	5.99	3.19
1 1/4	6100-20	6120-20	1 1/4-11 1/2 NPTF	6.48	4.25
1 1/2	6100-24	6120-24	1 1/2-11 1/2 NPTF	6.80	6.13

Coupling Set with Hex Nut



Body Size	Part Number With Flange	Part Number Without Flange	Thread Size	Overall Connected Length	Weight (lbs.)
3/4	6110-08	6130-08	1/2-14 NPTF	5.20	1.89
3/4	6110-12	6130-12	3/4-14 NPTF	5.20	1.83
1	6110-16	6130-16	1-11 1/2 NPTF	5.99	2.93
1 1/4	6110-20	6130-20	1 1/4-11 1/2 NPTF	6.33	4.12
1 1/2	6110-24	6130-24	1 1/2-11 1/2 NPTF	6.55	5.95

Dust Caps for Nipples



Body Size	Dust Cap - Nipples
3/4	6108-08
1	6108-16
1 1/4	6108-20
1 1/2	6108-24

Dust Plugs for Couplers



Body Size	Dust Plug - Couplers
3/4	6109-08
1	6109-16
1 1/4	6109-20
1 1/2	6109-24

Optional Seal Materials:

(add code to part number)

Code	Description	Part Number Example
suffix W	Ethylene Propylene seal material- EPR	6135-08W
suffix Y	Fluorocarbon seal material	6135-08Y
suffix Z	Neoprene seal material	6135-08Z

Contact QCD for availability and additional options.
To select proper seal materials, see Fluid Compatibility Chart or contact QCD.



Couplers - Wingnut



Body Size	Part Number Brass	Thread Size	Overall Length	Wrench Flats	Wing Nut	Weight (lbs.)
3/4	6125-08	1/2-14 NPTF	3.22	1.16	4.06	1.30
3/4	6125-12	3/4-14 NPTF	3.22	1.16	4.06	1.26
1	6125-16	1-11 1/2 NPTF	3.87	1.43	4.38	1.96
1 1/4	6125-20	1 1/4-11 1/2 NPTF	4.16	1.78	5.20	2.84
1 1/2	6125-24	1 1/2-11 1/2 NPTF	4.34	2.00	5.32	3.72

Couplers - Hex Nut



Body Size	Part Number Brass	Thread Size	Overall Length	Wrench Flats	Hex Size	Weight (lbs.)
3/4	6135-08	1/2-14 NPTF	3.22	1.16	1.75	1.07
3/4	6135-12	3/4-14 NPTF	3.22	1.16	1.75	1.07
1	6135-16	1-11 1/2 NPTF	3.87	1.43	2.13	1.89
1 1/4	6135-20	1 1/4-11 1/2 NPTF	4.16	1.78	2.50	2.56
1 1/2	6135-24	1 1/2-11 1/2 NPTF	4.34	2.00	2.75	3.15

Nipples



Body Size	Part Number Without Flange Brass	Part Number With Flange Brass	Thread Size	Overall Length	Wrench Flats	Hex Size	Weight (lbs.)
3/4	6105-08	6115-08	1/2-14 NPTF	3.11	1.18	1.62	0.75
3/4	6105-12	6115-12	3/4-14 NPTF	3.23	1.18	1.62	0.76
1	6105-16	6115-16	1-11 1/2 NPTF	3.55	1.56	1.88	1.30
1 1/4	6105-20	6115-20	1 1/4-11 1/2 NPTF	3.71	1.88	2.13	1.65
1 1/2	6105-24	6115-24	1 1/2-11 1/2 NPTF	4.12	2.18	2.50	2.61

Mounting Flanges



Body Size	Part Number Steel	Bolt Hole Diameter	Bolt Circle Diameter
3/4	6107-08 (1 piece)	.208	2.13
1	6107-16 (1 piece)	.208	2.38
1 1/4	6107-20 (2 piece)	.208	2.63
1 1/2	6107-24 (2 piece)	.281	3.25



Parker's 8200 Series unique valve design allows connection while either or both the coupler and nipple are under pressure. Valves in both halves remain closed, opening only when system pressure has been relieved on the female body and then reapplied. This pressure sequence may be done with either an open center or a closed center hydraulic system that has a control valve.

Features:

- Accepts ISO 5675 universal tips
- Connect under system pressure on the coupler side and residual pressure on the nipple side
- Sleeve designed to accommodate bracket mounting
- One-handed push-to-connect operation when coupler is clamp mounted
- 1/2" body size couplers are compatible with 5001-4 and 5006-4 breakaway clamps
- Critical parts are hardened
- Protective zinc plating with clear trivalent chromate finish

Applications include:

- Tractors
- Mid-sized agricultural equipment
- Agricultural attachments requiring breakaway

8200 Series Specifications

Body Size	Rated Flow	Rated Pressure	Temperature	Body Material	Sleeve Type	Seal Material
1/2	12 gpm	3000 psi	-40° F to +250° F	Steel	Push/pull/break away	Nitrile

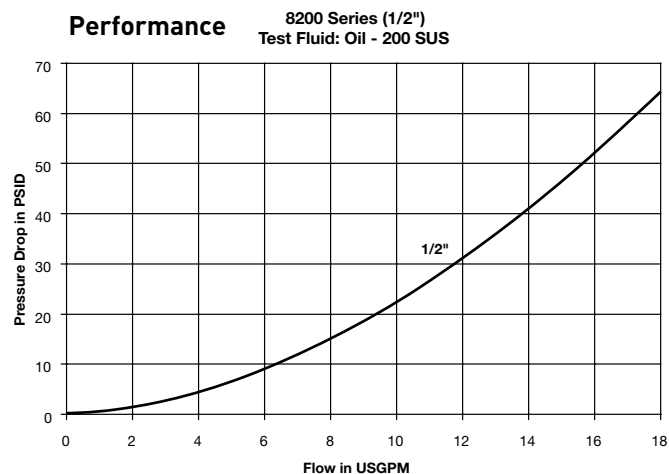

Optional Seal Materials:

(add code to part number)

Code	Description	Part Number Example
suffix W	Ethylene Propylene seal material- EPR (Couplers)	8250-15W
suffix Y	Fluorocarbon seal material (Couplers)	8250-15Y
suffix Z	Neoprene seal material (Couplers)	8250-15Z

Contact QCD for availability and additional options.

To select proper seal materials, see Fluid Compatibility Chart or contact QCD.



8200 Series Couplers - Female Thread



Body Size	Coupler Part Number	Port End	Valve Type	Length	Largest Diameter	Wrench Flats	Weight (lbs.)	Complete Coupling Part Number
1/2	8250-4	1/2-14 NPSF	Poppet	3.29	1.50	0.87	0.63	8200-4
1/2	8250-15	3/4-16 ORB	Poppet	3.29	1.50	0.87	0.63	8200-15
1/2	8250-16	7/8-14 ORB	Poppet	3.29	1.50	0.87	0.63	8200-16

8010 Series Nipples - Female Thread



Body Size	Nipple Part Number	Port End	Valve Type	Length	Largest Diameter	Wrench Flats	Weight (lbs.)	Complete Coupling Part Number
1/2	8010-4	1/2-14 NPTF	Ball	1.95	1.23	1.06	0.20	8200-4
1/2	8010-4P	1/2-14 NPTF	Poppet	1.95	1.23	1.06	0.20	-
1/2	8010-15	3/4 -16 ORB	Ball	1.95	1.23	1.06	0.20	8200-15
1/2	8010-15P	3/4 -16 ORB	Poppet	1.95	1.23	1.06	0.20	-
1/2	8010-16	7/8 -14 ORB	Ball	1.95	1.23	1.06	0.25	8200-16
1/2	8010-16P	7/8 -14 ORB	Poppet	1.95	1.23	1.06	0.25	-

8200 Series Replacement Parts

Body Size	Part Number	Description	Material
1/2	50005-211-0200	O-Ring	Nitrile

8200 Series Dust Caps and Plugs



Body Size	Dust Plug (Coupler)	Color/Material	Dust Cap (Nipple)	Weight (lbs.)
1/2	5205-4M	Black Rubber	5209-4M	.04
1/2	5005-4	Steel w/Chain	5009-4	.21
1/2	5205-4M-BU	Blue Rubber	5209-4M-BU	.04
1/2	5205-4M-GR	Green Rubber	5209-4M-GR	.04
1/2	5205-4M-RE	Red Rubber	5209-4M-RE	.04
1/2	5205-4M-YE	Yellow Rubber	5209-4M-YE	.04



The 9200 Series coupler allows zero pressure connection and disconnection while either or both the coupler and nipple are under pressure. A lever operated cam locks both coupler and nipple valves in the open or closed position. "Closed", the flow is shut off at the coupler, allowing easy connect and disconnect. Valves in the "Open" position are locked in place and unaffected by hydraulic surges. Valves will automatically close if the coupling is accidentally disconnected.



Features:

- Accepts ISO 5675 universal tips
- Premier connect under pressure coupling
- Locked valves prevent flow checking
- Functionally can replace a double shut-off quick coupling and two high pressure ball valves
- Protective zinc plating with clear trivalent chromate finish

Applications include:

- Mobile equipment
- Industrial hydraulics
- Not recommended for use with gaseous or compressible media

9200 Series Specifications:						
Body Size	Rated Flow	Rated Pressure	Temperature	Body Material	Sleeve Type	Seal Material
1/2	12 gpm	3000 psi	-40° F to +250° F	Steel	Push/pull/breakaway	Nitrile

Performance:

9200 Series (1/2")
Test Fluid: Oil - 200 SUS

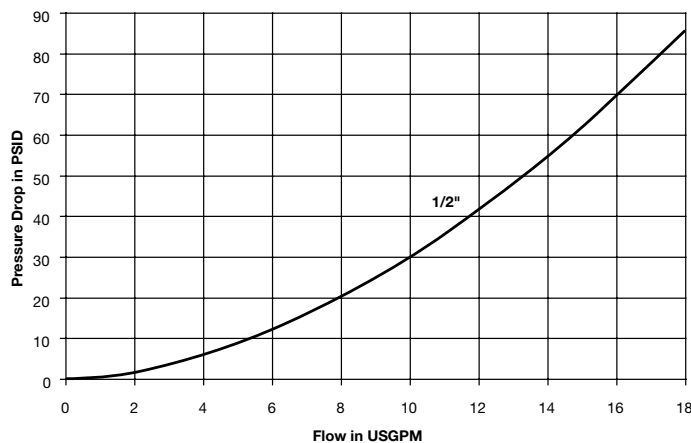

Optional Seal Materials:

[add code to part number]

Code	Description	Part Number Example
suffix W	Ethylene Propylene seal material- EPR (Couplers)	9250-4-320W
suffix Y	Fluorocarbon seal material (Couplers)	9250-4-320Y
suffix Z	Neoprene seal material (Couplers)	9250-4-320Z

Contact QCD for availability and additional options.
To select proper seal materials, see Fluid Compatibility Chart or contact QCD.



9200 Series Couplers



Body Size	Coupler Part Number	Port End	Valve Type	Orientation	Length	Largest Diameter	Wrench Flats	Weight (lbs.)
1/2	9250-4-320*	1/2-14 NPTF	Poppet	Left hand – yellow grip	5.37	1.50	1.13	1.98
1/2	9250-6-320*	9/16-18 UNF	Poppet	Left hand – yellow grip	5.37	1.50	1.13	2.06
1/2	9250-15-320*	3/4-16 UNF	Poppet	Left hand – yellow grip	5.37	1.50	1.13	2.06
1/2	9250-16-320*	7/8-14 UNF	Poppet	Left hand – yellow grip	5.37	1.50	1.13	2.06
1/2	9250-334**	9/16-18 UNF	Poppet	Left hand – yellow grip	5.37	1.50	1.13	2.15

* -320 indicates lower sleeve spring force for easier connection when coupler is not mounted in a clamp.

** -334 couplers connect with 1/4" ISO 7241-B series nipples.

8010 Series Nipples



Body Size	Nipple Part Number	Port End	Valve Type	Length	Largest Diameter	Wrench Flats	Weight (lbs.)
1/4	H2-63-T6*	9/16-18 ORB	Poppet	1.54	1.01	0.88	0.10
1/2	8010-4	1/2-14 NPTF	Ball	1.95	1.23	1.06	0.20
1/2	8010-4P	1/2-14 NPTF	Poppet	1.95	1.23	1.06	0.20
1/2	8010-15	3/4-16 ORB	Ball	1.95	1.23	1.06	0.20
1/2	8010-15P	3/4-16 ORB	Poppet	1.95	1.23	1.06	0.20
1/2	8010-16	7/8-14 ORB	Ball	1.95	1.23	1.06	0.25
1/2	8010-16P	7/8-14 ORB	Poppet	1.95	1.23	1.06	0.25

* Connects with 9250-334 couplers

9200 Series Replacement Parts

Body Size	Part Number	Description	Weight (lbs.)
1/2	50001-211-0260	Interface O-Ring	.01

9200 Series Dust Caps and Plugs



Body Size	Coupler Dust Cover	Color/Material	Nipple Dust Cap	Weight (lbs.)
1/2	9507-4-1	Black Rubber	5209-4M	.04



The 5000 Series is an economical coupling that can be connected under pressure where tools can be used to make the connection. The coupler and nipple are connected and then the valves are opened from tightening the threaded union on the back of the coupler body. Unscrewing the body threads will permit the valves to close and the coupler sleeve can be retracted to release the nipple.

Features:

- Accepts ISO 5675 universal tips
- Manual, threaded actuation, connect under pressure coupling
- Protective zinc plating with clear trivalent chromate finish

Applications include:

- Lubrication systems
- Hydraulic tools
- Attachments

5000 Series Specifications						
Body Size	Rated Flow	Rated Pressure	Temperature	Body Material	Sleeve Type	Seal Material
1/2	12 gpm	2500 psi	-40° F to +250° F	Steel	Single Acting	Nitrile

Performance:

5000 Series (1/2")
Test Fluid: Oil - 200 SUS

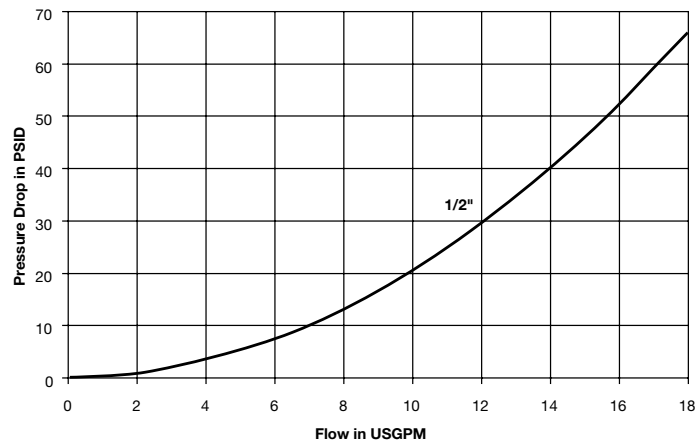



5000 Series Couplers



Body Size	Coupler Part Number	Port End	Valve Type	Length	Largest Diameter	Wrench Flats	Weight (lbs.)	Complete Coupling Part Number
1/2	5050-4	1/2-14 NPTF	Ball	2.88	1.52	1.25	2.58	5000-4

8010 Series Nipples



Body Size	Nipple Part Number	Port End	Valve Type	Length	Largest Diameter	Wrench Flats	Weight (lbs.)	Complete Coupling Part Number
1/2	8010-4	1/2-14 NPTF	Ball	1.95	1.23	1.06	0.20	5000-4
1/2	8010-15	3/4-16 ORB	Ball	1.95	1.23	1.06	0.20	-
1/2	8010-16	7/8-14 ORB	Ball	1.95	1.23	1.06	0.25	-

5000 Replacement Parts

1/2

O-Rings - Nitrile	50001-211-0260
--------------------------	----------------

5000 Series Dust Caps and Plugs



Body Size	Dust Plug (Coupler)	Color/Material	Dust Cap (Nipple)	Weight (lbs.)
1/2	5205-4M	Black Rubber	5209-4M	.04
1/2	5205-4M-BU	Blue Rubber	5209-4M-BU	.04
1/2	5205-4M-GR	Green Rubber	5209-4M-GR	.04
1/2	5205-4M-RE	Red Rubber	5209-4M-RE	.04
1/2	5205-4M-YE	Yellow Rubber	5205-4M-YE	.04
1/2	5005-4	Steel w/Chain	5009-4	.21

Optional Seal Materials:

(add code to part number)

Code	Description	Part Number Example
suffix W	Ethylene Propylene seal material- EPR (Couplers)	5050-4W
suffix Y	Fluorocarbon seal material (Couplers)	5050-4Y
suffix Z	Neoprene seal material (Couplers)	5050-4Z

Contact QCD for availability and additional options.
To select proper seal materials, see Fluid Compatibility Chart or contact QCD.

Hydraulic Quick Couplings

Connect Under Pressure

Snap-tite 75 Series

Threaded Connection

Poppet valves, high pressure



The rugged 75 Series is designed and constructed for high pressure hydraulic service. Although these couplings are used in a broad variety of heavy duty applications, a primary usage is in oil fields and offshore drilling. Available in sizes 3/4" through 4", in steel or stainless steel construction.

Features:

- Connect under residual pressure
- Thread-to-connect
- Up to 5,000 psi (345 bar) rated pressures
- Rugged steel construction with Zinc Trivalent Chromate plating
- Stainless steel construction also available
- Wide range of sizes
- Nitrile is standard seal material, other options available
- DBP version is "Fire Safe" rated to API 16D

Applications include:

- Cranes
- Power tongs
- Horizontal boring and dewatering

75 Series Pressure Ratings			
Body Size	Maximum Working Pressure (psi) Steel Only	Minimum Burst Pressure (psi) Steel Only	Maximum Working Pressure (psi) 316 Stainless (Connected Only)
3/4	5000	20000	3000
1	5000	20000	3000
1-1/4	5000	15000	3000
1-1/2	5000	15000	3000
2	5000	15000	3000
2-1/2	3000	6000	-
3	3000	6000	-
4	400	1000	-

Burst pressures listed were taken at the point at which failure rendered the quick-disconnect inoperative. (Proof pressure equals 1-1/2 times the operating pressure).

NOTE: Pressure Ratings were established under static pressure conditions.

For impulse applications, multiply the above pressure ratings by .6 for approximate pressure ratings.

-Contact QCD

75 Series Specifications								
Body Size	3/4	1	1-1/4	1-1/2	2	2-1/2	3	4
Spillage (cc)	8	16	31	64	141	204	320	400
Air Inclusion (cc)	12	25	48	98	205	368	480	610



Performance

Torque Values for Connecting Under Pressure

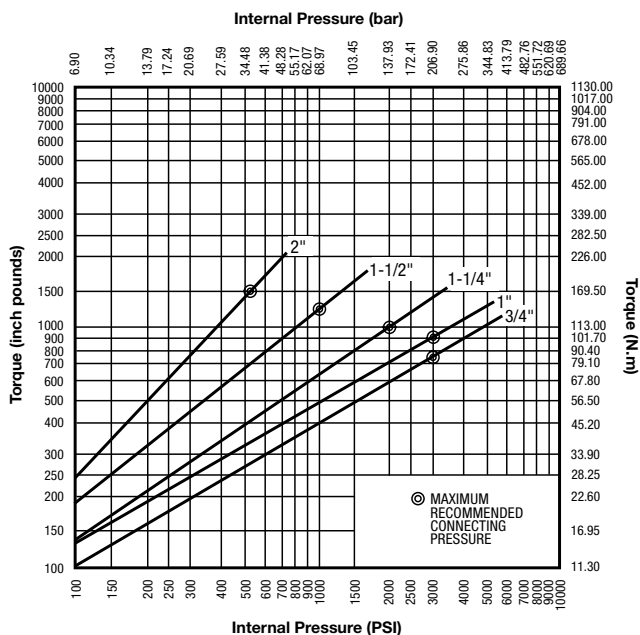

Flow Chart

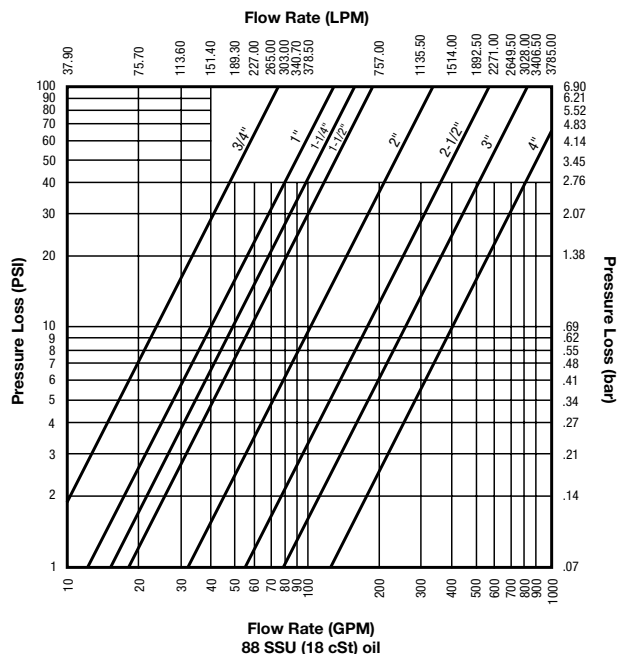

75 Series Dust Plugs and Caps

Body Size	3/4	1	1-1/4	1-1/2	2	2-1/2	4
Dust Plugs (Coupler)	75MDP-12	75MDP-16	75MDP-20	75MDP-24	75MDP-32	75MDP-40	75MDP-64
Dust Caps (Nipple)	75MDC-12	75MDC-16	75MDC-20	75MDC-24	75MDC-32	75MDC-40	75MDC-64

75 Series Repair Kits

Body Size	3/4	1	1-1/4	1-1/2	2	2-1/2	4
Coupler Kit	75C12-SPK	75C16-SPK	75C20-SPK	75C24-SPK	75C32-SPK	75C40-SPK	75C64-SPK
Nipple Kit	75N12-SPK	75N16-SPK	75N20-SPK	75N24-SPK	75N32-SPK	75N40-SPK	75N64-SPK

Each kit contains a valve assembly, spring and guide stop. Consult QCD for "DBP" option seals.



75 Series Couplers



Body Size	Part Number Steel	Port End	Part Number 316 Stainless Steel	Port End	Length (in)	Largest Diameter	Wrench Flats
3/4	75C12-12F	3/4-14 NPSF	S75C12-12F	3/4-14 NPSF	2.84	2.06	1.31
3/4	75C12-12F-DBP	3/4-14 NPSF	-	-	2.84	2.06	N/A
1	75C16-16F	1-11-1/2 NPSF	S75C16-16F	1-11-1/2 NPSF	3.45	4.25	1.69
1	75C16-16F-DBP	1-11-1/2 NPSF	-	-	3.45	4.25	N/A
1-1/4	75C20-20F	1-1/4-11-1/2 NPTF	S75C20-20F	1-1/4-11-1/2 NPT	4.40	4.75	2.00
1-1/4	75C20-20F-DBP	1-1/4-11-1/2 NPTF	-	-	4.40	4.75	N/A
1-1/2	75C24-24F	1-1/2-11-1/2 NPTF	S75C24-24F	1-1/2-11-1/2 NPT	5.04	5.75	2.25
1-1/2	75C24-24F-DBP	1-1/2-11-1/2 NPTF	-	-	5.04	5.75	N/A
2	75C32-32F	2-11-1/2 NPT	S75C32-32F	2-11-1/2 NPT	6.07	6.75	3.00
2	75C32-32F-DBP	2-11-1/2 NPT	-	-	6.07	6.75	3.00
2-1/2	75C40-40F	2-1/2-8 NPTF	S75C40-40F	2-1/2-8 NPTF	5.29	8.00	3.50
3	75C48-48F	3-8 NPTF	S75C48-48F	3-8 NPTF	5.84	8.50	4.25

75 Series Nipples



Body Size	Part Number Steel	Port End	Part Number 316 Stainless Steel	Port End	Length (in)	Largest Diameter	Wrench Flats
3/4	75N12-12F	3/4-14 NPSF	S75N12-12F	3/4-14 NPSF	3.27	1.75	1.56
3/4	75N12-12F-DBP	3/4-14 NPSF	-	-	3.27	1.75	N/A
1	75N16-16F	1-11-1/2 NPSF	S75N16-16F	1-11-1/2 NPSF	4.17	2.25	2.00
1	75N16-16F-DBP	1-11-1/2 NPSF	-	-	4.17	2.25	N/A
1-1/4	75N20-20F	1-1/4-11-1/2 NPTF	S75NC20-20F	1-1/4-11-1/2 NPT	5.36	2.62	2.38
1-1/4	75N20-20F-DBP	1-1/4-11-1/2 NPTF	-	-	5.36	2.62	N/A
1-1/2	75N24-24F	1-1/2-11-1/2 NPTF	S75N24-24F	1-1/2-11-1/2 NPT	5.97	3.25	2.88
1-1/2	75N24-24F-DBP	1-1/2-11-1/2 NPTF	-	-	5.97	3.25	N/A
2	75N32-32F	2-11-1/2 NPT	S75N32-32F	2-11-1/2 NPT	7.05	4.00	3.50
2	75N32-32F-DBP	2-11-1/2 NPT	-	-	7.05	4.00	N/A
2-1/2	75N40-40F	2-1/2-8 NPTF	S75N40-40F	2-1/2-8 NPTF	7.46	5.00	3.50
3	75N48-48F	3-8 NPTF	S75N48-48F	3-8 NPTF	8.26	6.00	4.25

Contact QCD for additional sizes and end configurations.

Optional Seal Materials and Features for Couplers and Nipples (add code to part number)

Code	Description	Part Number Example
suffix V	Fluorocarbon seal material	75C12-12F V
suffix E	Ethylene Propylene seal material (EPR)	75C12-12F E
suffix W	Wrench flats on body (standard on 2-1/2" and larger, no code required)	75C12-12F W
suffix DBP	"Fire Safe" BOP version (3/4" - 2" steel only, no alternate seal options)	SB-75C12-12F- DBP

Contact QCD for availability and additional options.

To select proper seal materials, see Fluid Compatibility Chart or contact QCD.



Parker's Snap-tite 71 Series couplings are designed for working pressures up to 10,000 psi. Available in a variety of materials and with a wide range of body sizes. Air inclusion and fluid loss are minimal with the flush face valves. Large flow chambers in the body and an exclusive valve design permit superior flow while maintaining low pressure drop.

Features:

- Flush face/Non-spill
- Push-to-connect
- Heavy duty construction
- Designed for up to 10,000 psi (690 bar) working pressures
- Variety of materials
- Wide range of sizes
- Superior flow and low pressure drop
- Sleeve lock option to protect against accidental disconnection.

Applications include:

- Industrial hydraulic lines
- Off-shore drilling



71 Series Pressure Ratings						
Body Size	Steel		316 Stainless Steel		High Pressure Stainless Steel	
	Maximum Working (psi)	Minimum Burst* (psi)	Maximum Working (psi)	Minimum Burst* (psi)	Maximum Working (psi)	Minimum Burst* (psi)
1/4	10,000	20,000	5,000	12,500	10,000	20,000
3/8 x 1/4 ¹	10,000	20,000	5,000	12,500	10,000	20,000
3/8	10,000	20,000	5,000	12,500	10,000	20,000
3/8 x 1/2 ²	10,000	20,000	5,000	12,500	10,000	20,000
1/2	10,000	20,000	5,000	12,500	10,000	20,000
3/4	7,500	15,000	5,000	12,500	7,500	15,000
1	7,500	15,000	4,000	10,000	7,500	15,000
1 x 1-1/4 ³	7,500	15,000	4,000	10,000	7,500	15,000
2 x 1-1/2 ⁴	5,000	10,000	3,000	6,000	5,000	10,000
2	5,000	10,000	3,000	6,000	5,000	10,000

¹Unit is 3/8" with 1/4" end fitting. ²Unit is 3/8" with 1/2" end fitting, ³1" unit with 1-1/4" end fitting, and ⁴2" unit with 1-1/2" end fitting.
***NOTE:** Pressure Ratings were established under static pressure conditions. For high impulse applications, consult QCD.

Specifications										
Body Size	1/4	3/8 x 1/4 ¹	3/8	3/8 x 1/2 ²	1/2	3/4	1	1 x 1-1/4 ³	2 x 1-1/4 ⁴	2
Spillage (cc)	.02	.02	.02	.02	.03	.06	.10	.10	5.25	5.25
Air Inclusion (cc)	.01	.02	.02	.02	.03	.04	.06	.06	30.50	30.50

Maximum Recommended Connect/Disconnect Pressures				
Body Size	1/4	3/8, 1/2, 3/4	1, 1-1/4	1-1/2, 2
Pressure	300	150	75	0



Performance

Sizes 1/4 thru 1-1/4

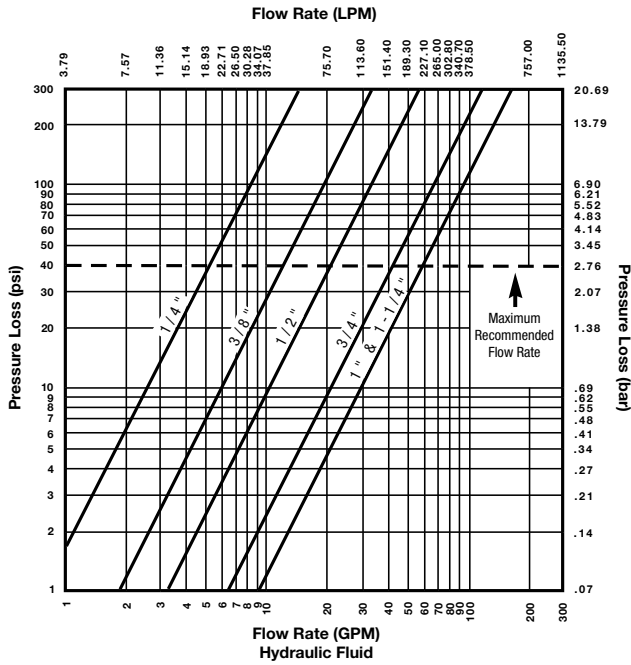

Sizes 1-1/2 and 2

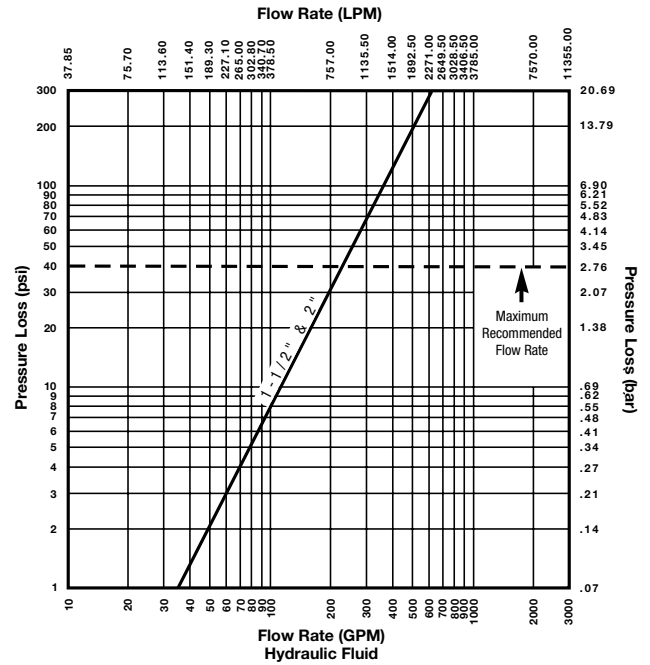

Gallons per minute (gpm) in US gallons. Test Media MIL-H-6083 Hydraulic Fluid at 90°F ± 5°F [+32°C ± 1.5°C] sg .83

Ordering Guide

71-3 C 4 - 4 F

- Options:**
SL = Sleeve Lock
- Seals:**
Standard Seal = Nitrile
V = Fluorocarbon
E = Ethylene Propylene
M = MHO
- End Fitting Type:**
F* = Female NPTF
EF = Female SAE
RP = Female British Parallel BS2779
Autoclave cone & threaded fittings available (consult QCD)
- End Fitting Size:**
4 = 1/4" 16 = 1"
6 = 3/8" 20 = 1-1/4"
8 = 1/2" 24 = 1-1/2"
12 = 3/4" 32 = 2"
- Coupling Body Size:**
4 = 1/4" 12 = 3/4"
6 = 3/8" 16 = 1"
8 = 1/2" 32 = 2"
- Coupling Half:**
C = Coupler
N = Nipple
- Series:**
71 = 1-1/2" & 2" Nipples Only
71-1 = 1-1/2" & 2" Couplers Only
71-3 = 1/4" thru 1-1/4" Both
- Material:**
Blank = Steel, zinc trivalent plating
S = 316 Stainless Steel
SH = High Pressure Stainless Steel

* For sizes up to 1" NPTF threads in steel.
For sizes up to 1" NPSF threads in stainless steel.
For sizes over 1" NPT threads.



71 Series Couplers



Body Size	Part Number Steel	Port End	Part Number 316 Stainless Steel	Part Number High Pressure Stainless Steel	Port End	Length (in)	Largest Dia.	Wrench Flats
1/4	71-3C4-4F	1/4 - 18 NPTF	S71-3C4-4F	SH71-3C4-4F	1/4 - 18 NPTF	1.96	1.19	0.94
1/4	71-3C4-4EF	7/16 - 20 UNF	S71-3C4-4EF	-	7/16 - 20 UNF	1.96	1.19	0.94
3/8	71-3C6-4F	1/4 - 18 NPTF	-	-	-	2.36	1.56	1.19
3/8	71-3C6-6F	3/8 - 18 NPTF	S71-3C6-6F	SH71-3C6-6F	3/8 - 18 NPSF	2.36	1.56	1.19
3/8	71-3C6-6EF	9/16 - 18 UNF	S71-3C6-6EF	SH71-3C6-6EF	9/16 - 18 UNF	2.36	1.56	1.19
3/8	71-3C6-8F	1/2 - 14 NPTF	S71-3C6-8F	-	1/2 - 14 NPSF	2.57	1.56	1.19
1/2	71-3C8-8F	1/2 - 14 NPTF	S71-3C8-8F	SH71-3C8-8F	1/2 - 14 NPSF	2.77	1.88	1.50
1/2	71-3C8-8EF	7/8 - 14 UNF	S71-3C8-8EF	-	7/8 - 14 UNF	2.77	1.88	1.50
3/4	71-3C12-12F	3/4 - 14 NPTF	S71-3C12-12F	SH71-3C12-12F	3/4 - 14 NPSF	3.05	2.25	1.75
3/4	71-3C12-12EF	1-1/16 - 12 UNF	S71-3C12-12EF	-	1-1/16 - 12 UNF	3.05	2.25	1.75
1	71-3C16-16F	1 - 11-1/2 NPTF	S71-3C16-16F	SH71-3C16-16F	1 - 11-1/2 NPSF	3.32	2.63	2.00
1	71-3C16-16EF	1-5/16 - 12 UNF	S71-3C16-16EF	-	1-5/16 - 12 UNF	3.32	2.63	2.00
1	71-3C16-20F	1-1/4 - 11-1/2 NPT	S71-3C16-20F	-	1-1/4 - 11-1/2 NPT	3.32	2.63	2.00
1	71-3C16-20EF	1-5/8 - 12 UNF	S71-3C16-20EF	-	1-5/8 - 12 UNF	3.32	2.63	2.00
2	71-1C32-24F	1-1/2 - 11-1/2 NPT	-	-	-	6.21	4.50	3.38
2	71-1C32-24EF	1-7/8 - 12 UNF	-	-	-	6.21	4.50	3.38
2	71-1C32-32F	2 - 11-1/2 NPT	-	-	-	6.21	4.50	3.38
2	71-1C32-32EF	2-1/2 - 12 UNF	-	-	-	6.21	4.50	3.38



71 Series Nipples



Body Size	Part Number Steel	Port End	Part Number 316 Stainless Steel	Part Number High Pressure Stainless Steel	Port End	Length (in)	Largest Dia.	Wrench Flats
1/4	71-3N4-4F	1/4 - 18 NPTF	S71-3N4-4F	SH71-3N4-4F	1/4 - 18 NPTF	1.84	0.89	0.81
1/4	71-3N4-4EF	7/16 - 20 UNF	S71-3N4-4EF	-	7/16 - 20 UNF	1.84	0.89	0.81
3/8	71-3N6-4F	1/4 - 18 NPTF	-	-	-	1.84	1.18	1.00
3/8	71-3N6-6F	3/8 - 18 NPTF	S71-3N6-6F	SH71-3N6-6F	3/8 - 18 NPSF	2.32	1.18	1.00
3/8	71-3N6-6EF	9/16 - 18 UNF	S71-3N6-6EF	SH71-3N6-6EF	9/16 - 18 UNF	2.32	1.18	1.00
3/8	71-3N6-8F	1/2 - 14 NPTF	-	-	-	2.57	1.65	1.25
1/2	71-3N8-8F	1/2 - 14 NPTF	S71-3N8-8F	SH71-3N8-8F	1/2 - 14 NPSF	2.38	1.65	1.50
1/2	71-3N8-8EF	7/8 - 14 UNF	S71-3N8-8EF	SH71-3N8-8EF	7/8 - 14 UNF	2.38	1.65	1.50
3/4	71-3N12-12F	3/4 - 14 NPTF	S71-3N12-12F	SH71-3N12-12F	3/4 - 14 NPSF	2.96	1.92	1.75
3/4	71-3N12-12EF	1-1/16 - 12 UNF	S71-3N12-12EF	-	1-1/16 - 12 UNF	2.96	1.92	1.75
1	71-3N16-16F	1 - 11-1/2 NPTF	S71-3N16-16F	SH71-3N16-16F	1 - 11-1/2 NPSF	3.23	2.09	1.88
1	71-3N16-16EF	1-5/16 - 12 UNF	S71-3N16-16EF	-	1-5/16 - 12 UNF	3.23	2.09	1.88
1	71-3N16-20F	1-1/4 - 11-1/2 NPT	S71-3N16-20F	-	1-1/4 - 11-1/2 NPT	3.23	2.20	1.88
1	71-3N16-20EF	1-5/8 - 12 UNF	S71-3N16-20EF	-	1-5/8 - 12 UNF	3.23	2.20	1.88
2	71N32-24F	1-1/2 - 11-1/2 NPT	-	-	-	4.50	3.50	3.25
2	71N32-24EF	1-7/8 - 12 UNF	-	-	-	4.50	3.50	3.25
2	71N32-32F	2 - 11-1/2 NPT	-	-	-	4.50	3.50	3.25



The 3000 Series coupling are designed for high pressure applications. The coupler sleeve and nipple body must be manually threaded together to make the connection.

Features:

- Manual threaded connection and actuation
- Hard, chrome alloy ball valves
- Polyurethane interface seal resists high pressure extrusion
- Threaded retainer provides a positive valve stop
- Protective zinc plating with clear trivalent chromate finish

Applications include:

- Hydraulic rams
- Portable hydraulic tools
- Crimping equipment



3000 Series Specifications

Body Size	Rated Flow (gpm)	Rated Pressure (psi)	Temperature	Body Material	Sleeve Type	Seal Material
1/4	3	10,000	-22° F to +230° F	Steel	Thread to connect	Polyurethane
3/8	6			Steel	Thread to connect	Polyurethane

Performance:

3000 Series (1/4", 3/8")
Test Fluid: Oil - 200 SUS

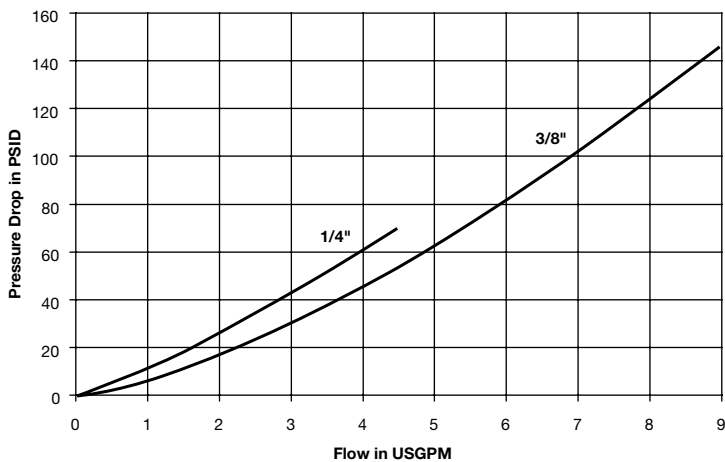



3000 Series Couplers



Body Size	Coupler Part Number	Port End	Valve Type	Length	Largest Diameter	Wrench Flats	Weight (lbs.)
1/4	3050-2	1/4-18 NPTF (Male)	Ball	2.38	1.13	0.81	0.25
3/8	3050-3	3/8-18 NPTF (Male)	Ball	2.38	1.38	1.00	0.49
3/8	3050-3-231	3/8-18 NPTF (Female)	Ball	2.38	1.38	1.00	0.49

3000 Series Nipples



Body Size	Nipple Part Number	Port End	Valve Type	Length	Largest Diameter	Wrench Flats	Weight (lbs.)
1/4	3010-2	1/4-18 NPTF (Female)	Ball	1.29	1.13	0.88	0.14
3/8	3010-3	3/8-18 NPTF (Female)	Ball	1.58	1.25	0.94	0.23
3/8	3010-3-230	3/8-18 NPTF (Male)	Ball	2.31	1.25	1.00	0.30

3000 Series Replacement O-Rings

Body Size	Material	Part Number	Durometer
1/4	Polyurethane	50001-114-0296	90
3/8	Polyurethane	50001-210-0296	90

3000 Series Dust Caps and Plugs



Body Size	Dust Cap (Nipple)	Color/Material	Dust Plug (Coupler)	Weight (lbs.)
1/4	3009-2	Steel	3005-2	.02
3/8	3009-3	Steel	3005-3	.04

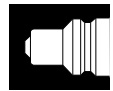

TC Series couplings are used in high pressure applications with hydraulic and mechanical shock. Steel coupler sleeves and nipple bodies are hardened for resistance to damage. Fluorocarbon seals along with PTFE back up rings provide reliable sealing in high pressures. Available in 3/8 inch size only, with sleeve lock to guard against accidental disconnection.

Features:

- Rated pressure up to 10,000 psi
- Manual sleeve operation
- Fluorocarbon seals
- Standard sleeve lock guards against accidental disconnection
- Positive valve stop prevents flow checking
- Standard end configuration is female pipe thread
- Protective zinc plating with clear trivalent chromate finish

Applications:

- Hydraulic jacking and house moving equipment
- Construction equipment
- Railway maintenance

Performance

TC Series (3/8")
Test Fluid: Oil - 200 SUS

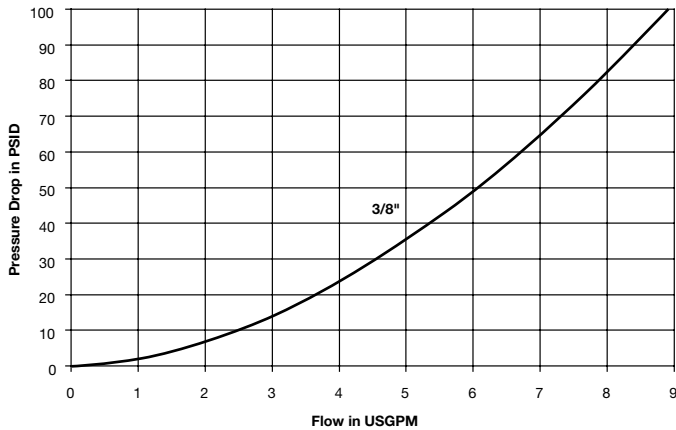

Specifications

Body Size	3/8
Rated Pressure (psi)	10,000
Rated Flow (gpm)	6
Temperature Range (std seals)	-15° to +400° F

TC Series Dust Plug/Caps

TR-37

Coupler



Body Size	Part Number	Thread Size	Overall Length	Largest Diameter	Wrench Flats	Weight (lbs.)
3/8	TC-371	3/8-18 NPSF	2.48	1.25	0.94	0.43

Nipple



Body Size	Part Number	Thread Size	Overall Length	Exposed Length	Largest Diameter	Wrench Flats	Weight (lbs.)
3/8	TC-372	3/8-18 NPSF	1.82	0.66	1.08	0.94	0.14



1141 Series are general purpose couplings that connect under pressure for high pressure applications. The 1/4 inch stainless steel coupling connects together with a threaded brass sleeve. Polyurethane seals resist extrusion and abrasion.

Features:

- 303 stainless steel body
- Rated pressure up to 10,000 psi and 17,000 psi intermittent pressure
- Small diameter mating seal keeps separation forces to a minimum, allowing easier threaded connection and disconnection at pressures up to 5,000 psi
- Polyurethane seals to resist extrusion and abrasion
- Self locking threads guard against accidental disconnection
- Visual connection indicator – when fully coupled, sleeve edge is flush with the end of the male thread
- Standard end configuration is female pipe thread
- Dust caps and plugs included

Applications:

- Off shore equipment
- Hydraulic lines in corrosive environments

Specifications	
Body Size	1/4
Rated Pressure (psi)	10,000
Rated Connect-Under-Pressure Capability (psi)	5,000
Rated Flow (gpm)	3
Temperature Range (Polyurethane seals)	-30° to +180° F
Vacuum Test	20 in/Hg
Torque to connect at 1000 psi	47 in/lbs.

Coupler



Body Size	Part Number	Thread Size	Length	Sleeve Hex	Wrench Flat	Weight (lbs.)
1/4	1141-62	1/4-18 NPTF	2.75	1.00	0.88	0.40

Nipple



Body Size	Part Number	Thread Size	Length	Wrench Flat	Weight (lbs.)
1/4	1141-63	1/4-18 NPTF	2.00	0.88	0.26



ST Series non-valved couplings provide maximum flow and low pressure drop. The smooth, open bore allows easy cleaning in applications where the same lines are used for more than one media.

Features

- Steel nipples are case hardened for resistance to Brinelling
- Functionally interchanges with similar straight-through design couplings
- Standard Nitrile seals
- Material options available
- Sleeve-Lok option available

Applications:

- High pressure water
- Steam washers
- Carpet cleaners



Specifications

Body Size	Rated Pressure (psi) Brass Coupler/Nipple	Rated Pressure (psi) Brass Coupler/Steel Nipple	Rated Pressure (psi) 303 SS Coupler/Nipple	Temperature Range (standard seals)	Rated Flow
1/8	2500	2600	4200	-40° to +250° F	3
1/4	5200	5500	6700		6
3/8	2700	3500	5500		12
1/2	2200	2700	3000		12
3/4	1700	2700	3000		28
1	1200	2000	1700		50
1-1/4	1700	-	-		76
1-1/2	1400	-	-		100

Performance

ST Series (1/8", 1/4", 3/8", 1/2")
Test Fluid: Oil - 150 SUS

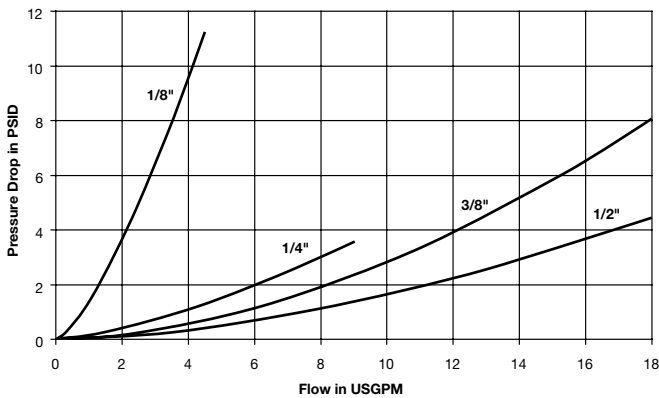

ST Series (3/4", 1", 1-1/4")
Test Fluid: Oil - 150 SUS

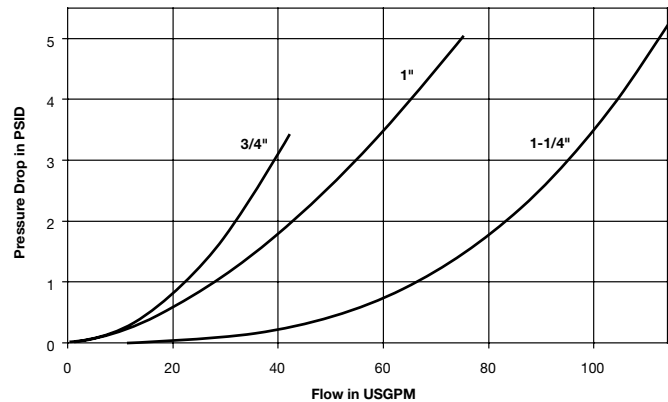



ST Series Couplers - Female Pipe Thread



Body Size	Brass Part Number	303 Stainless Part Number	Port End	Length	Largest Diameter	Wrench Flats	Brass Weight (lbs.)	Stainless Weight (lbs.)
1/8	BST-1	SST-1	1/8-27 NPTF	1.06	0.69	0.56	0.06	0.05
1/4	BST-2	SST-2	1/4-18 NPTF	1.54	0.94	0.81	0.17	0.15
3/8	BST-3	SST-3	3/8-18 NPTF	1.64	1.16	1.00	0.26	0.24
1/2	BST-4	SST-4	1/2-14 NPTF	1.98	1.30	1.13	0.40	0.37
3/4	BST-6	SST-6	3/4-14 NPTF	2.15	1.66	1.44	0.62	0.57
1	BST-8	SST-8	1-11 1/2 NPTF	2.43	2.02	1.75	0.99	0.93
1-1/4	BST-10	-	1 1/4-11 1/2 NPTF	2.44	2.51	2.00	1.38	-
1-1/2	BST-12	-	1 1/2-11 1/2 NPTF	2.88	3.00	2.50	2.43	-

ST Series Couplers - Male Pipe Thread



Body Size	Brass Part Number	303 Stainless Part Number	Port End	Length	Largest Diameter	Wrench Flats	Brass Weight (lbs.)	Stainless Weight (lbs.)
1/8	BST-1M	SST-1M	1/8-27 NPTF	1.06	0.69	0.56	0.05	0.05
1/4	BST-2M	SST-2M	1/4-18 NPTF	1.69	0.94	0.81	0.13	0.16
3/8	BST-3M	SST-3M	3/8-18 NPTF	1.75	1.16	1.00	0.25	1.16
1/2	BST-4M	SST-4M	1/2-14 NPTF	1.94	1.30	1.13	0.34	1.30
3/4	BST-6M	SST-6M	3/4-14 NPTF	2.17	1.66	1.44	-	1.66
1	BST-8M	SST-8M	1-11 1/2 NPTF	2.53	2.02	1.75	0.85	2.02

Optional Materials and Features:

(add code to part number)

Code	Description	Part Number Example
suffix -SL	Sleeve-Lok (Couplers)	SST-3M-SL
suffix W	Ethylene Propylene seal material- EPR (Couplers)	SST-3MW
suffix Y	Fluorocarbon seal material (Couplers)	SST-3MY
suffix Z	Neoprene seal material (Couplers)	SST-3MZ

Contact QCD for availability and additional options.

To select proper seal materials, see Fluid Compatibility Chart or contact QCD.



ST Series Nipples- Female Pipe Thread



Body Size	Brass Part No.	Weight. (lbs.)	Steel Part No.	Weight. (lbs.)	303 Stainless Part No.	Weight. (lbs.)	Length	Largest Diameter	Wrench Flats
1/8	BST-N1	0.03	ST-N1	0.03	SST-N1	0.02	0.98	0.65	0.56
1/4	BST-N2	0.07	ST-N2	0.07	SST-N2	0.07	1.46	0.87	0.75
3/8	BST-N3	0.12	ST-N3	0.11	SST-N3	0.11	1.62	1.59	0.08
1/2	BST-N4	0.23	ST-N4	0.21	SST-N4	0.21	1.85	1.30	1.13
3/4	BST-N6	0.33	ST-N6	0.32	SST-N6	0.32	2.15	1.59	1.38
1	BST-N8	0.52	ST-N8	0.49	SST-N8	0.48	2.35	1.88	1.63
1-1/4	BST-N10	0.85	-	-	-	-	2.38	2.31	2.00
1-1/2	BST-N12	1.45	-	-	-	-	2.81	2.74	2.38

ST Series Nipples- Male Pipe Thread



Body Size	Brass Part No.	Weight. (lbs.)	Steel Part No.	Weight. (lbs.)	303 Stainless Part No.	Weight. (lbs.)	Length	Largest Diameter	Wrench Flats
1/8	BST-N1M	0.02	ST-N1M	0.02	SST-N1M	0.02	1.04	0.51	0.44
1/4	BST-N2M	0.06	ST-N2M	0.05	SST-N2M	0.05	1.53	0.65	0.56
3/8	BST-N3M	0.08	ST-N3M	0.07	SST-N3M	0.08	1.69	0.79	0.69
1/2	BST-N4M	0.15	ST-N4M	0.13	SST-N4M	0.13	1.94	1.01	0.88
3/4	BST-N6M	0.23	ST-N6M	0.21	SST-N6M	0.22	2.19	1.23	1.06
1	BST-N8M	0.46	ST-N8M	0.43	SST-N8M	0.43	2.51	1.59	1.38
1-1/4	BST-N10M	0.96	-	-	-	-	2.85	2.17	1.88
1-1/2	BST-N12M	1.46	-	-	-	-	3.25	2.45	2.13



Parker Water Service Quick Couplings add convenience and efficiency wherever water hoses are frequently connected and disconnected. The durable 4-ball locking mechanism provides a secure connection.

Features:

- Brass and stainless steel construction
- Nitrile seals

Applications include:

- Garden hoses
- Wash down systems
- Mobile water tank lines

Specifications			
Body Size	Rated Pressure (psi)	Rated Flow (gpm)	Temperature Range (std seals)
3/4	200	28	-40° to +250° F

Coupler					
Body Size	Coupler Part Number	Port End	Length	Largest Diameter	Weight (lbs.)
3/4	1163-60	3/4-11 1/2 NH	1.16	1.21	0.12

Nipple					
Body Size	Nipple Part Number	Port End	Overall Length	Exposed Length	Weight (lbs.)
3/4	1163-61	3/4-11 1/2 NH	1.25	0.50	0.08

Hydraulic Quick Couplings

High Flow

HO Series

Non-Valved, High Pressure

Manual sleeve, sleeve lock



HO series couplings are high flow, high pressure, steel couplings for a wide variety of applications. Electroless nickel plating provides corrosion resistance.

Features:

- Steel material with electroless nickel plating
- Nitrile seals with PTFE back up ring
- No valving, unrestricted flow
- Standard sleeve lock guards against accidental disconnection
- Rated pressures up to 15,000 psi

Applications:

- Paper and pulp processing
- Refinery systems
- Testing systems

Specifications

Body Size	1/4	3/8	1/2
Rated Pressure (PSI)	15,000	15,000	10,000
Rated Flow (GPM)	3	6	12
Temperature Range (std seals)	-40° to +250°F		

Couplers



Body Size	Part Number	Thread Size	Overall Length	Largest Diameter	Wrench Flats	Weight (lbs.)	Dust Plug Rubber
1/4	HO-251-4FP	1/4-18 NPTF	1.67	1.06	0.94	0.24	TR-37
3/8	HO-371-6FP	3/8-18 NPTF	1.67	1.06	0.94	0.22	TR-37
1/2	HO-501-8FP	1/2-14 NPTF	2.03	1.62	1.25	0.52	DP-50

Optional Seal Materials:

Code	Description	Part Number Example
suffix -E5	Ethylene Propylene seal material- EPR (Couplers)	HO-371-6FP-E5
suffix -E4	Fluorocarbon seal material (Couplers)	HO-371-6FP-E4
suffix -E12	Neoprene seal material (Couplers)	HO-371-6FP-E12

To select proper seal materials, see Fluid Compatibility Chart or contact QCD Contact QCD for availability..

Nipples



Body Size	Part Number	Thread Size	Overall Length	Exposed Length	Largest Diameter	Wrench Flats	Weight (lbs.)	Dust Plug Rubber
1/4	HO-252-4FP	1/4-18 NPTF	1.40	0.66	0.94	0.81	0.10	TR-37
3/8	HO-372-6FP	3/8-18 NPTF	1.44	0.70	1.08	0.94	0.12	TR-37
1/2	HO-502-8FP	1/2-14 NPTF	2.03	0.86	1.30	1.12	0.26	DP-50



Performance Moldmate Series (1/4", 3/8", 1/2")
Test Fluid: Water (Straight Coupler)

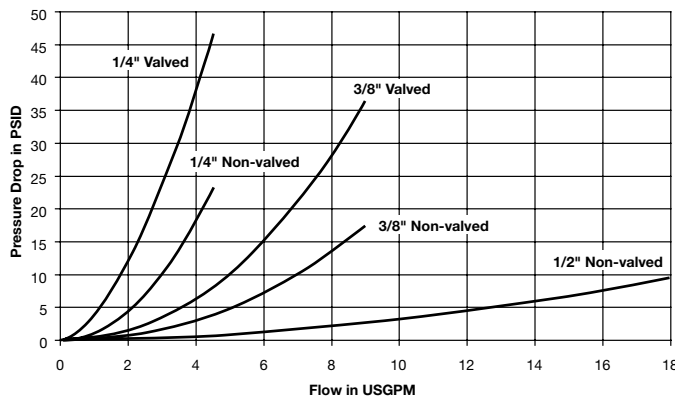

Guidelines for Selection and Use:

Non-valved couplers provide maximum flow for efficient cooling. Valved couplers shut off automatically when disconnected. Valved couplers can be used with either valved or non-valved nipples. A valved nipple, however, must be used with a valved coupler.

Moldmate couplings are rated for 200 psi max pressure. Most thermoplastic and thermoset heat transfer systems have pumps which provide relatively high flow rates at low pressures. Water and water glycol systems usually have capacities ranging from 10 to 40 gpm with most from 10 to 15 gpm. Normal medial opening pressures are 20 to 60 psi for these systems. Heat transfer systems using oil generally operate from 10 to 30 psi. However, their flow rates are usually much higher, requiring the total volume of oil to be circulated at least once per minute.

The number of hose connections in a single mold system results in a cumulative pressure drop. Please note the Pressure Drop vs. Flow Rate chart provided, to select the appropriate size.

Temperature is another important consideration. Parker Moldmate couplings with the standard silicone seal have a temperature capability of -90° to +400°F. Rapid deterioration of the seal and leakage may result if used beyond these limits.

External conditions of temperature, corrosive atmospheres, and other abnormalities may affect coupling performance and must be considered when selection is made. Consult QCD with questions.

Moldmate series couplings are specifically designed for connecting coolant lines to molds and dies on injection molding machinery and die casting equipment. These couplings significantly reduce downtime, by providing a quick and easy way to connect and disconnect lines during mold changes.

Features:

- Rated pressure is 200 psi
- Valved and unvalved options. Valved couplers have silver colored sleeves
- Brass material with standard silicone interface seals are compatible with water and water glycol fluids. Valved versions have a fluorocarbon seal on the poppet.
- Optional fluorocarbon seal for use with oil based media
- Short nipples can be installed recessed below the mold surface enabling more efficient storage and protecting the nipple from damage
- Standard and Push-Lok hose barb ends are available in straight, 45 or 90 degree configurations
- Manual sleeve operation
- Extension nipples are offered in several lengths

Applications:

- Mold coolant lines
- Die casting equipment

Special Order Information:

Standard seal material is Silicone and is compatible with water and water glycol fluids commonly used in heat transfer systems. Fluorocarbon seals are available for use with oil-based media. To specify a Fluorocarbon seal, add the suffix "Y" to the standard moldmate part number, thus: PC206Y.

Specifications

Body Size	1/4	3/8	1/2
Rated Pressure (psi)	200		
Rated Flow (gpm)	3	6	12

Material

Temperature Range

Standard Silicone seal	-20° to +400° F
*Optional Fluorocarbon seal	-15° to +400° F

* For use with oil based media only



B Hydraulics

Couplers - Straight



Push-Lok Hose Barb



Standard Hose Barb

Body Size	Part Number Brass Non-Valved	Weight (lb.)	Part Number Brass Valved	Weight (lb.)	Hose I.D.	Overall Length	Largest Diameter	Non-Valved		Wrench Flats
								Overall Length	Largest Diameter	
1/4	PC204	0.10	PC204AV	0.10	1/4	1.87	0.63	2.67	0.71	0.63
1/4	PC204-BP*	0.10	PC204AV-BP	0.10	1/4	1.89	0.63	2.52	0.71	0.63
1/4	PC205	0.09	PC205AV	0.10	5/16	1.87	0.63	2.67	0.71	0.63
1/4	PC206	0.09	PC206AV	0.10	3/8	1.87	0.63	2.67	0.71	0.63
1/4	PC206-BP*	0.11	PC206AV-BP	0.13	3/8	2.04	0.63	2.70	0.71	0.63
3/8	PC306	0.24	PC306V	0.27	3/8	3.01	0.96	3.17	1.01	0.88
3/8	PC306-BP*	0.26	PC306V-BP	0.29	3/8	3.15	0.96	3.31	1.01	0.88
3/8	PC308	0.25	PC308V	0.28	1/2	3.15	0.96	3.17	1.01	0.88
3/8	PC308-BP*	0.25	PC308V-BP	0.03	1/2	3.27	0.96	3.43	1.01	0.88
1/2	PC504	0.46	NA	-	1/2	3.55	1.30			-
1/2	PC504-BP*	0.50	NA	-	1/2	3.68	1.21			-
1/2	PC506	0.48	NA	-	3/4	3.80	1.21			-
1/2	PC506-BP*	0.52	NA	-	3/4	3.80	1.21			-

NA = Not Available

Couplers - 45 Degree



Push-Lok Hose Barb



Standard Hose Barb

Body Size	Part Number Brass Non-Valved	Weight (lb.)	Part Number Brass Valved	Weight (lb.)	Hose I.D.	Overall Length	Largest Diameter	Wrench Flats	Non-Valved		Wrench Flats
									Overall Length	Largest Diameter	
1/4	PC224	0.13	PC224AV	0.13	1/4	2.67	0.71	0.56	2.87	0.71	0.63
1/4	PC224-BP*	0.13	PC224AV-BP	0.14	1/4	2.57	0.71	0.56	2.77	0.71	0.63
1/4	PC226	0.13	PC226AV	0.14	3/8	2.71	0.71	0.56	2.91	0.71	0.63
1/4	PC226-BP*	0.26	PC226AV-BP	0.17	3/8	2.74	0.71	0.56	2.94	0.71	0.63
3/8	PC326	0.36	PC326V	0.36	3/8	3.65	0.96	0.88	3.65	1.01	0.88
3/8	PC326-BP*	0.34	PC326V-BP	0.36	3/8	3.75	0.96	0.88	3.75	1.01	0.88
3/8	PC328	0.36	PC328V	0.36	1/2	3.69	0.96	0.88	3.69	1.01	0.88
3/8	PC328-BP*	0.34	PC328V-BP	0.40	1/2	3.88	0.96	0.88	3.88	0.96	0.88
1/2	PC524	0.74	NA	-	1/2	4.18	1.21	1.12			-
1/2	PC524-BP*	0.78	NA	-	1/2	4.28	1.21	1.12			-
1/2	PC526	0.76	NA	-	3/4	4.56	1.21	1.12			-
1/2	PC526-BP*	0.80	NA	-	3/4	4.56	1.21	1.12			-

* Suffix BP in part number denotes Push-Lok hose barb. Without suffix denotes standard hose barb.

Push-Lok hose barbs are designed for use with Parker Push-Lok hose and do not require clamps.

Valved Couplers can be used with either non-valved or valved nipples.





Couplers - 90 Degree



Push-Lok Hose Barb



Standard Hose Barb

Body Size	Part No. Brass Non-Valved	Weight (lb.)	Part No. Brass Valved (silver sleeve)	Weight (lb.)	Hose I.D.	Overall Length	Wrench Flats	Largest Diameter	Overall Length	Wrench Flats	Largest Diameter
						Non-Valved			Valved		
1/4	PC214	0.13	PC214AV	0.14	1/4	1.78	0.56	0.71	1.98	0.63	0.71
1/4	PC214-BP*	0.14	PC214AV-BP	0.14	1/4	1.78	0.56	0.71	1.98	0.63	0.71
1/4	PC215	0.13	PC215AV	0.14	5/16	1.78	0.56	0.71	1.98	0.63	0.71
1/4	PC216	0.14	PC216AV	0.15	3/8	1.78	0.56	0.71	1.98	0.63	0.71
1/4	PC216-BP*	0.16	PC216AV-BP	0.17	3/8	1.80	0.56	0.71	2.00	0.63	0.71
3/8	PC316	0.31	PC316V	0.31	3/8	2.78	0.88	0.96	2.78	0.88	0.96
3/8	PC316-BP*	0.37	PC316V-BP	0.37	3/8	2.78	0.88	0.96	2.78	0.88	0.96
3/8	PC318	0.33	PC318V	0.35	1/2	2.78	0.88	0.96	2.78	0.88	0.96
3/8	PC318-BP*	0.37	PC318V-BP	0.39	1/2	2.80	0.88	0.96	2.80	0.88	0.96
1/2	PC514	0.79	NA	-	1/2	3.50	1.12	1.21		-	
1/2	PC514-BP*	0.83	NA	-	1/2	3.50	1.12	1.21		-	
1/2	PC516	0.80	NA	-	3/4	3.50	1.12	1.21		-	
1/2	PC516-BP*	0.84	NA	-	3/4	3.50	1.12	1.21		-	

* Suffix BP in part number denotes Push-Lok hose barb. Without suffix denotes standard hose barb.
 Push-Lok hose barbs are designed for use with Parker Push-Lok hose and do not require clamps.
 Valved Couplers can be used with either non-valved or valved nipples.

Sub Assemblies and Individual Replacement Parts

Non-valved Sub-assembly (Brass Sleeve)



Body Size	Part No. Brass Non-Valved	Weight (lb.)	Thread Size	Length	Largest Diameter	Wrench Flats
1/4	P208-01A	0.07	1/8-27 NPTF	1.15	0.71	0.56
3/8	P308-01A	0.21	1/4-18 NPTF	1.84	0.96	0.88
3/8	P308-01A-HF	0.20	3/8-18 NPTF	1.84	0.96	0.88
1/2	PC500	0.34	1/2-14 NPTF	2.02	1.21	1.12

Valved Sub-assembly (Silver Colored Sleeve)





Bodies are designed for use with a valve and spring retained by a male pipe fitting (i.e. hose barb). Valve, valve spring, and end fitting are not included with sub-assembly and must be ordered separately.

Body Size	Part No. Brass Valved	Weight (lb.)	Thread Size	Length	Largest Diameter	Wrench Flats
1/4	P201-01A	0.07	1/8-27 NPTF	1.35	0.71	0.56
3/8	P301-01A	0.21	1/4-18 NPTF	1.84	0.96	0.88



Sub Assemblies and Individual Replacement Parts

Valves (for Valved Sub-assembly)			Valve Springs (for Valved Sub-assembly)		
					
Body Size	Part Number	Material	Body Size	Part Number	Material
1/4	3613001	Brass	1/4	7820123	Stainless
3/8	P300-11S	Brass	3/8	P300-6	Stainless

Replacement Seals (for both Valved and Non-valved)					
					
Body Size	Part Number	Material	Body Size	Part Number	Material
1/4	P200-9A	* Silicone	1/4	P200-9AY	* Fluorocarbon
3/8	P300-9A	* Silicone	3/8	P300-9AY	* Fluorocarbon
1/2	P500-9A	* Silicone	1/2	P500-9AY	* Fluorocarbon

* Note: Bulk seals are not returnable.

Assembly Instruction Sheet (for all sizes & configurations)
Part Number
9090065

B Hydraulics



Nipples - Female Pipe Thread



Body Size	Part No. Brass	Weight (lb.) Brass	Part No. Steel	Weight (lb.) Steel	Thread Size	Overall Length	Exposed Length**	Wrench Flats	Largest Diameter
1/4	BPN251F	0.02	PN251F	0.02	1/8-27 NPTF	0.97	0.58	0.50	0.58
1/4	BPN252F	0.05	PN252F	0.04	1/4-18 NPTF	1.28	0.89	0.63	0.72
1/4	BPN253F	0.08	PN253F	0.08	3/8-18 NPTF	1.41	1.02	0.75	0.87
3/8	BPN352F	0.05	PN352F	0.05	1/4-18 NPTF	1.48	0.88	0.63	0.72
3/8	BPN353F	0.07	PN353F	0.06	3/8-18 NPTF	1.58	0.98	0.75	0.87

Nipples - Male Pipe Thread



Body Size	Part No. Brass	Weight (lb.) Brass	Part No. Steel	Weight (lb.) Steel	Thread Size	Overall Length	Exposed Length**	Wrench Flats	Largest Diameter	Install Recess Diameter	Depth
1/4	PN250	0.02	-	-	1/16-27 NPTF	0.94	0.54	0.44	0.51	0.69	0.69
1/4	PN251	0.02	PN251S	0.02	1/8-27 NPTF	0.94	0.54	0.44	0.51	0.69	0.69
1/4	PN252	0.03	PN252S	0.03	1/4-18 NPTF	1.13	0.74	0.56	0.67	0.84	0.94
1/4	PN253	0.05	PN253S	0.05	3/8-18 NPTF	1.19	0.79	0.69	0.79	1.00	0.94
3/8	PN352	0.04	PN352S	0.04	1/4-18 NPTF	1.34	0.74	0.56	0.65	1.00	1.09
3/8	PN353	0.06	PN353S	0.06	3/8-18 NPTF	1.38	0.78	0.69	0.79	1.00	1.13
3/8	PN354	0.12	NA	-	1/2-14 NPTF	1.59	0.99	0.88	1.01	1.19	1.25
1/2	PN553	0.12	NA	-	3/8-18 NPTF	1.53	0.77	0.88	1.01	1.25	1.34
1/2	PN554	0.11	NA	-	1/2-14 NPTF	1.70	0.94	0.88	1.01	1.25	1.50
1/2	PN556	0.16	NA	-	3/4-14 NPTF	1.75	0.99	1.06	1.23	1.50	1.56

Valved Nipple



Body Size	Part Number Brass	Thread Size	Overall Length	**Exposed Length	Largest Diameter	Wrench Flats	Weight (lb.)
1/4	BPV252*	1/4-18 NPTF	1.21	0.82	0.67	.56	0.03
3/8	BPV353*	3/8-18 NPTF	1.48	0.88	0.79	.69	0.07

*Valved Nipple must be used with Valved Coupler.

**This dimension represents the portion of the nipple that is exposed when inserted into a moldmate coupler.

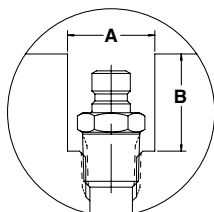

Install Recess Diameter	Depth
0.84	0.94
1.00	1.23



Nipples - Moldmate Extension



Body Size	Part Number Brass	Weight (lb.) Brass	Thread Size	Overall Length	Length	Wrench Flats	Largest Diameter
1/4	PN250-25	0.04	1/16-27 NPTF	2.50	.69	3/8	0.43
1/4	PN250-40	0.06	1/16-27 NPTF	4.00	.81	3/8	0.43
1/4	PN250-55	0.09	1/16-27 NPTF	5.50	.81	3/8	0.43
1/4	PN251-25	0.06	1/8-27 NPTF	2.50	.69	7/16	0.51
1/4	PN251-40	0.10	1/8-27 NPTF	4.00	1.00	7/16	0.51
1/4	PN251-55	0.13	1/8-27 NPTF	5.50	1.00	7/16	0.51
1/4	PN251-70	0.17	1/8-27 NPTF	7.00	1.00	7/16	0.51
1/4	PN251-85	0.21	1/8-27 NPTF	8.50	1.00	7/16	0.51
1/4	PN252-25	0.09	1/4-18 NPTF	2.50	.88	9/16	0.65
1/4	PN252-40	0.15	1/4-18 NPTF	4.00	1.25	9/16	0.65
1/4	PN252-55	0.22	1/4-18 NPTF	5.50	1.25	9/16	0.65
1/4	PN252-70	0.27	1/4-18 NPTF	7.00	1.25	9/16	0.65
1/4	PN252-85	0.33	1/4-18 NPTF	8.50	1.25	9/16	0.65
3/8	PN351-25	0.07	1/8-27 NPTF	2.50	.88	9/16	0.65
3/8	PN351-40	0.11	1/8-27 NPTF	4.00	1.00	9/16	0.65
3/8	PN351-55	0.15	1/8-27 NPTF	5.50	1.00	9/16	0.65
3/8	PN351-70	0.18	1/8-27 NPTF	7.00	1.00	9/16	0.65
3/8	PN351-85	0.22	1/8-27 NPTF	8.50	1.00	9/16	0.65
3/8	PN352-25	0.09	1/4-18 NPTF	2.50	.88	9/16	0.65
3/8	PN352-40	0.15	1/4-18 NPTF	4.00	1.25	9/16	0.65
3/8	PN352-55	0.21	1/4-18 NPTF	5.50	1.25	9/16	0.65
3/8	PN352-70	0.27	1/4-18 NPTF	7.00	1.25	9/16	0.65
3/8	PN352-85	0.33	1/4-18 NPTF	8.50	1.25	9/16	0.65
3/8	PN353-25	0.12	3/8-18 NPTF	2.50	1.00	11/16	0.79
3/8	PN353-40	0.20	3/8-18 NPTF	4.00	1.25	11/16	0.79
3/8	PN353-55	0.28	3/8-18 NPTF	5.50	1.25	11/16	0.79
3/8	PN353-70	0.37	3/8-18 NPTF	7.00	1.25	11/16	0.79
3/8	PN353-85	0.45	3/8-18 NPTF	8.50	1.25	11/16	0.79

B Hydraulics



DM Series are special purpose miniature couplings that offer double shut-off and push to connect operation in a small envelope. The 1/8 inch brass couplings are nickel plated with standard fluorocarbon seals.

Features:

- Rated pressure is 250 psi
- Double shut-off valving
- Fluorocarbon seals
- Standard end configurations are female and male pipe thread

Applications:

- Dental equipment
- Lubrication lines
- Fluid transfer
- Coolant lines

Performance

DM Series (1/8")
Test Fluid: Water

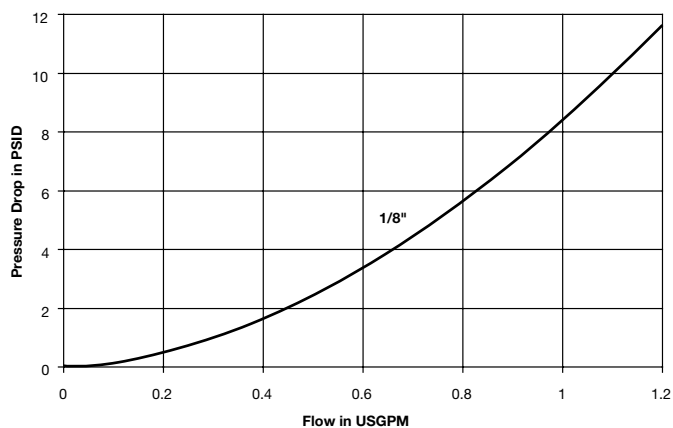

Specifications

Body Size (in.)	1/8
Rated Pressure (psi)	250
Locking Device (balls)	5
Rated Flow (gpm)	0.8
Temperature Range	-15°F to +400°F

How To Order

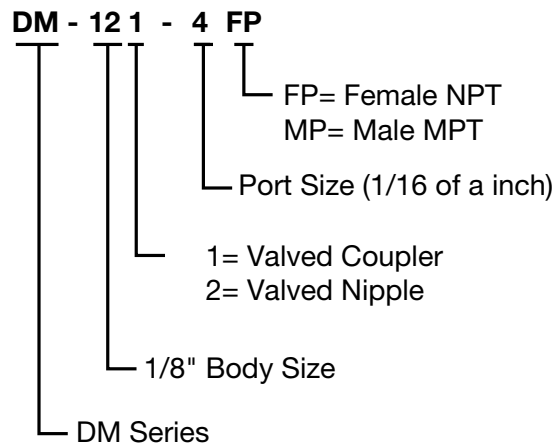



Couplers - Female Pipe Thread



Body Size	Part Number	Weight (lb.)	Thread Size	Overall Length	Largest Diameter	Wrench Flats
1/8	DM-121-2FP	0.06	1/8-27 NPTF	1.42	0.63	0.55
1/8	DM-121-4FP	0.10	1/4-18 NPTF	1.81	0.78	0.67

Couplers - Male Pipe Thread



Body Size	Part Number	Weight (lb.)	Thread Size	Overall Length	Largest Diameter	Wrench Flats
1/8	DM-121-2MP	0.06	1/8-27 NPTF	1.50	0.63	0.55
1/8	DM-121-4MP	0.07	1/4-18 NPTF	1.61	0.63	0.55

Nipples - Female Pipe Thread



Body Size	Part Number	Weight (lb.)	Thread Size	Overall Length	Exposed Length*	Largest Diameter	Wrench Flats
1/8	DM-122-2FP	0.05	1/8-27 NPTF	1.56	1.03	0.63	0.55
1/8	DM-122-4FP	0.09	1/4-18 NPTF	1.97	1.44	0.78	0.67

* This dimension represents the portion that is exposed when a nipple is inserted into a Parker DM Series coupler.

Nipples - Male Pipe Thread



Body Size	Part Number	Weight (lb.)	Thread Size	Overall Length	Exposed Length*	Largest Diameter	Wrench Flats
1/8	DM-122-2MP	0.05	1/8-27 NPTF	1.65	1.12	0.63	0.55
1/8	DM-122-4MP	0.06	1/4-18 NPTF	1.77	1.24	0.63	0.55

* This dimension represents the portion that is exposed when a nipple is inserted into a Parker DM Series coupler.

When ordering Parker coupler bodies and nipples, please state the part number of each type of coupler body and each type of nipple desired. List coupler bodies and nipples as separate items rather than in combinations. Be sure to double check thread or hose sizes of items required.

Many of Parker's coupling products are available with unique non-standard options well suited to very specific applications. Examples of unusual end use applications might include: high temperatures (above 250° F), extremely caustic/corrosive solutions passing through the coupling, external/environmental corrosion situations, or other high wear and tear situations such as dragging the product along the ground. Please see the Fluid Compatibility Chart at the end of the catalog for a guide in selecting material for various media. It is always recommended that the Quick Coupling Division be contacted with any questions concerning specific product application needs.

Typically, a prefix or suffix is added to the base part number to specify a non-standard O-ring seal, or special option such as a sleeve lock. The Optional Seals Suffix chart illustrates the designations.

Optional Features

- Prefix "HD" for Heavy Duty Nipple
- Suffix "SL" for Coupler Sleeve-Lok
- Suffix "P" for Poppet Valve
- Suffix "BP" for Push-Lok Hose Barb
- Suffix "VA" for Valve Actuator

Optional Seals Suffix*

No suffix is required when ordering products with the standard Nitrile seals. When specifying an optional seal, refer to the following chart to determine the appropriate suffix.

Coupling Series	Ethylene Propylene	Fluoro-carbon	Neoprene	Perfluoro-elastomer
60 Series	W	Y	Z	***
6600 Series	W	Y	Z	***
SM Series	E5	E4	E12	***
HP Series	E5	E4	E12	***
4000 Series	W	Y	Z	N/A
4200 Series	W	Y	Z	N/A
NS Series	E5	E4	N/A	***
FF Series Std. is E4 ⁹	E5	E4	N/A	***
FH Series	E5	E4	N/A	***
FS Series	E5	STD	E12	***
6100 Series	W	Y	Z	N/A
5000 Series	W	Y	Z	N/A
8200 Series	W	Y	Z	N/A
9200 Series	W	Y	Z	N/A
3000 Series	Available with Polyurethane only (no suffix needed)			
TC Series	Available with Fluorocarbon only (no suffix needed)			
1141 Series	Available with Polyurethane only (no suffix needed)			
ST Series	W	Y	Z	
Water Service	Available with Nitrile only			
HO Series	E5	E4	E12	N/A
Moldmate Series Std. is Silicone	N/A	Y**	N/A	N/A

N/A = Not Available

STD = Standard (No Suffix Needed)

* To select proper seal materials, see Fluid Compatibility Chart in Appendices section, or contact your Parker Quick Coupling Distributor.

** Fluorocarbon seal available for use only with oil based media, not water glycol.

*** Contact QCD for Perfluoroelastomer seal options.